

UNITY FIRE PIT - 18" TALL

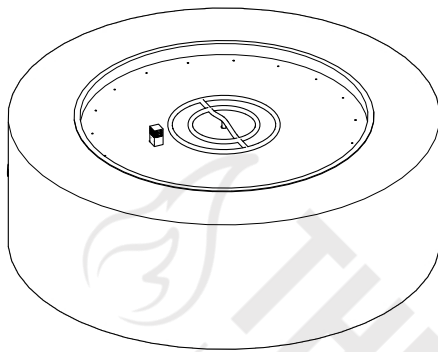

ISOMETRIC VIEW

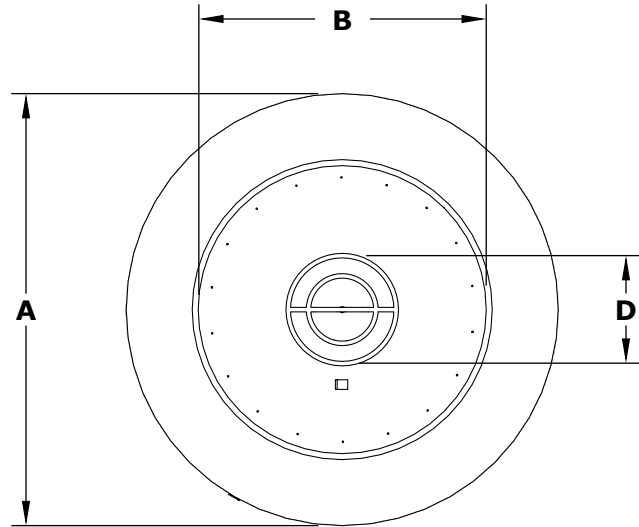

TOP VIEW

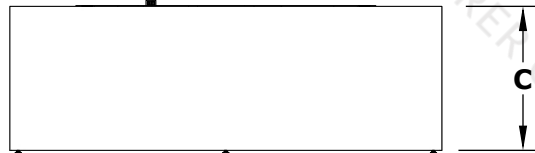

RIGHT SIDE VIEW



FRONT SIDE VIEW

Hammered Copper	Corten Steel	Stainless Steel	Powder Coat	A	B	C	D	BTU
OPT-UNYCP4818	OPT-RCRTN4818	OPT-UNYSS4818	OPT-UNYPC4818	48"	24"	18"	12"	65,000
OPT-UNYCP6018	OPT-RCRTN6018	OPT-UNYSS6018	OPT-UNYPC6018	60"	36"	18"	18"	160,000
OPT-UNYCP7218	OPT-RCRTN7218	OPT-UNYSS7218	OPT-UNYPC7218	72"	48"	18"	24"	190,000

Fire Pit Material: Various Metals
Pan Material: 304 Stainless Steel
Burner Material: 304 Stainless Steel

Standard 1" Flange on all pans
Standard 2" Depth on all pans

110V ELECTRONIC IGNITION
ANSI Z21.97-(2017) / CSA 2.41-(2017)



Match Lit Unit Includes: Pan, Burner, Gas Orifice, Gas Hoses, Key Valve, Key,

110v Ignition Unit Includes: Pan, Burner, Gas Orifice, Gas Hoses, Key Valve, Key, Plug & Play Electronic Valve, Pilot Igniter.

Drawn By	Murguia M.
Date Created	June 15, 2021