

DIAMOND SERIES

Users Manual



Read all instructions before you operate your grill.
Save these instructions!

⚠ ATTENTION: All Diamond Series come ready in Natural Gas. Gas conversion kit comes Included with all Diamond Series cooking appliance. See page 8 to convert to Propane.



LC16070-1

CERTIFIED TO ANSI STD
Z21.58,-2022 CSA STD 1.6 -2022
Outdoor Cooking Appliance

www.diamondgrillsbbq.com

To Installer: Leave this manual with grill for future reference.
To Consumer: Keep this manual for future reference.

⚠ ATTENTION: THE DIAMOND GRILL SERIES MUST BE INSTALLED ACCORDING TO THE INSTALLATION GUIDE SHOWN ON PAGES 8 THRU 24. IF YOUR GRILL INSTALLATION DOES NOT MEET THE BASIC SETUP INSTRUCTIONS ALL WARRANTIES MAY BE VOID. SEE WARRANTY ON LAST PAGE.

SAFETY INFORMATION

 **WARNING:** Do not try lighting this appliance without reading the lighting instructions section on this manual.

 **WARNING:** Keep any electrical supply cord and the fuel supply hose away from any heated surfaces.

 **WARNING:** Your grill will get very hot. Never lean over the cooking area while using your grill. Do not touch cooking surface.

 **WARNING: FOR OUTDOOR USE ONLY:**

- Do not store or use gasoline or other flammable vapors and liquids, in the vicinity of this or any other appliance.
- An LP-cylinder not connected for use shall not be stored in the vicinity of this or any other Appliance.
- For use with Natural Gas or Liquid Propane.

 **DANGER: FIRE OR EXPLOSION HAZARD:**

If you smell gas:

- Shut off gas to the appliance.
- Extinguish any open flame.
- If odor continues, leave the area immediately.
- After leaving the area, call your gas supplier or Fire Department.

 **DANGER: FLAMMABLE GAS UNDER PRESSURE**

Leaking LP-GAS may cause a fire or explosion if ignited, causing serious bodily injury or death. Contact an LP Gas Supplier for Repairs or disposal of this cylinder or unused LP-GAS.

- Know the odor of LP-GAS; if you hear, see, or smell leaking, immediately get everyone away from the cylinder and call the Fire Department, do not attempt repairs.
- LP-GAS is heavier than air and may settle in low places while scattering.
- Contact with liquid propane will cause freeze burn to the skin.
- Do not allow children to tamper or play with the cylinder.

 **ATTENTION:**

- It is the installer's responsibility to ensure a safe installation and to educate the end user as to proper operation. Leave this manual with the end user.
- Never alter product or configure product in anyway.
- Product is not intended to be started by wood or any other combustible material.
- Only use gas fuel, Natural Gas or Liquid Propane.

SAFETY INFORMATION

 **WARNING:** When Lighting the Grill. DO NOT RELEASE KNOB, GAS WILL CONTINUE TO FLOW.

 **WARNING:** Failure to open the lid while igniting the barbecue's burners, or not waiting 5 minutes to allow the gas to clear if the barbecue does not light, may result in an explosive flame-up which can cause serious bodily injury or death.

 **WARNING:** Inspect the hose before using the grill. If there is excessive abrasion or wear, or if the hose is cut, it must be replaced prior to the outdoor cooking gas appliance being put into operation. The replacement hose assembly shall be that specified by the manufacturer. Ensure the area around the barbecue is clear of flammable substances such as gasoline, yard debris, wood, etc. Ensure there is no blockage of the airflow through the vent space located below the face of the unit.

 **WARNING: OUTDOOR USE ONLY:** NEVER operate grill in enclosed areas, as this could lead to gas accumulating from a leak, causing an explosion or a carbon monoxide buildup which could result in injury or death. DO NOT use your grill in garages, breezeways, sheds or any enclosed area. NOT FOR USE BY CHILDREN. If these instructions are ignored, a hazardous fire or explosion could result in physical injury, death or property damage!

 **WARNING:**

1. DO NOT Store or use gasoline or other flammable liquids or vapors in the vicinity of this or any other appliance.

2. An LP cylinder not connected for use shall not be stored in the vicinity of this or any other Appliance.

 **WARNING: OUTDOOR USE ONLY:** Failure to adequately vent your outdoor kitchen cavity could result in an explosion or fire.

GAS SAFETY

- Finding and/or fixing a gas leak is NOT a “DO-IT-YOURSELF” procedure – ONLY USE A PROFESSIONAL.
- NEVER USE THE GRILL WITHOUT FIRST LEAK TESTING THE GAS CONNECTIONS INCLUDING ALL OF THE VALVES, FITTINGS, LINES ETC. (ALL GAS CONNECTIONS SHOULD BE CHECKED)
- WARNING: DO NOT USE OPEN FLAME TO CHECK FOR LEAKS. USE OF AN OPEN FLAME COULD RESULT IN A FIRE, EXPLOSION AND BODILY HARM.
- DO NOT SMOKE WHILE PERFORMING THE LEAK TEST. Any open flame will ignite the gas.
- Check to ensure that flexible hoses do not have any cuts and wear that may affect the safety before each use. Only the Factory supplied hose and regulator must be used. Use only replacement regulator and hose assemblies specified by DIAMOND GRILLS BBQ.

CHECKING FOR GAS LEAKS:

Perform a leak test before each use. In addition, whenever the gas cylinder is connected to the regulator or whenever any part of the gas system is disconnected or replaced, perform a leak test. As a safety precaution, remember to always leak test your appliance outdoors in a well-ventilated area. Never smoke or permit sources of ignition in the area while doing a leak test. Do not use a flame, such as a lighted match to test for leaks. Use a solution of soapy water

- Prepare a leak testing solution of soapy water by mixing in a spray bottle one part liquid soap to one part water.
- Make sure all the control knobs are in the OFF position .
- Turn on the gas
 - o On Natural Gas systems, turn the main feed valve to the appliance.
 - o On LP systems, turn the cylinder valve knob counter clockwise one turn to open.
- Apply the leak-testing solution by spraying it on joints of the gas delivery system. This includes all valves, pipe connections, joints, lines and every point from the gas source to the burners.
- Blowing bubbles in the soap solution and/or there is a faint gas smell (Typically Gas has an Egg Smell) indicates that a leak is present. Do not attempt to ignite the grill.
- Turn all control knobs back to the full OFF position.

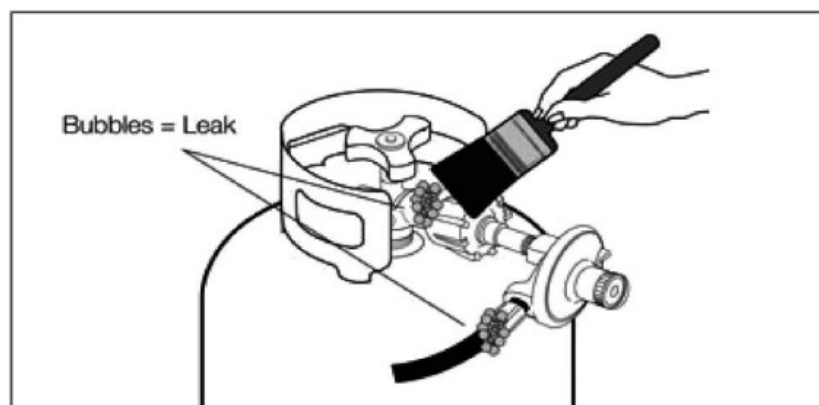

GAS SAFETY

- All gas connections should be made by a Professional qualified technician and in accordance with local codes and Ordinances. The installation must conform with local codes or, in the absence of local codes, with either the national Fuel Gas Code, ANSI Z223.1/NFPA 54, or CAN/CGA-B149.1, Natural Gas Installation Code or CAN/CGA-B149.2, Propane Installation Code.
- Check the rating label on the left hand outside of the unit
- Do not twist the gas supply hose.
- Before each use, visually inspect the gas supply hose for cracks, cuts or excessive wear. Replace the hose if necessary. Check for gas leaks before each use.
- Gas Specifications: A Natural Gas appliance requires natural gas to operate; an LP appliance requires liquid propane gas to operate.
- Never connect the appliance to an unregulated gas supply line. Appliances operated without a regulator are unsafe and will not be serviced until installed properly and safely. Unsafe operation without a gas regulator will void the warranty of the Appliance.
- Appliances operated with NG (natural gas) must be installed with the NG regulator supplied with the unit and set to 4.0" water column pressure.
- Appliances operated with LP (liquid propane) gas must be installed with an LP regulator set to 11" water column pressure.
- Please contact your dealer and use a licensed contractor or installer to convert your appliance to the different gas type.
- CHECK TO ENSURE THAT THE GAS SUPPLY HOSE DOES NOT COME IN CONTACT WITH ANY HOT SURFACE, SHARP OR ROUGH EDGES OF THE GRILL OR OUTDOOR KITCHEN CONSTRUCTION. DO NOT KINK THE GAS LINE WHEN INSTALLING.

The self-contained LP system appliance is design certified to be used with a standard 20 lb., 12 1/4" diameter; 18" high cylinder with right handed connection threads and this is the maximum size LP tank to be used. The cylinder must be marked in accordance with the latest U.S. Department of Transportation specifications for LP gas cylinders. (DOT. CFR49 or National Standards of Canada CAN/CSA-B359 Cylinders, Spheres and Tubes for the Transportation of Dangerous Goods) a Propane Tank with an OPD) Overfill Prevention Device) must be used at all times.

IMPORTANT: Never connect the appliance to an unregulated gas supply.

If there are local codes that apply to outdoor grills/griddles, you will have to confirm them with the local authority.

Installation must conform with local codes or in the absence of local codes, to the National Fuel Gas Code, ANSI Z223.1/NFPA 54 and Natural Gas Installation Code, CSA B149.1. All Natural Gas installations must conform to local codes or in the absence of local codes the national fuel gas code, ANSI-Z2223.1a - 1998.

If there are local codes that apply to outdoor burners, you will have to conform to them. Installation must conform with local codes or, in the absence of local codes, with Propane Installation Code, CSA B149.1, or Propane Storage and Handling Code, B149.2 as applicable.

Installation in Canada must be in accordance with the standard CAN/CGA- B149.2.

A licensed contractor or local gas company representative must perform all gas connections.

Ensure that the service supplying the appliance is fitted with a shut off valve conveniently positioned near the appliance and giving ease of access.

The appliance and its individual shutoff valve must be disconnected from the gas supply piping system during any Pressure testing of that system.

Table Of Contents

SAFETY

Safety Information.....	3
Gas Safety.....	4

GRILL INFORMATION

Removing Carter Pins.....	7
How to replace NG ORIFICE to LP ORIFICE.....	7
How to Install the REGULATOR.....	9
How to replace INFRARED ORIFICE.....	10
How to replace a burner for our High-Performance Infrared Burner.....	11
Grill Specification & Replacement Parts.....	13
Grill Location.....	16
Connecting the Transformer.....	21

Gas Hook Up

Propane Information.....	22
Natural Gas Information.....	26

Grill Start Up & Care

Grill Start Up.....	27
Rotisserie Set Up.....	28
Grill Features.....	30
Care & Maintenance.....	32

WARRANTY.....	34
---------------	----

IT IS THE RESPONSIBILITY OF THE INSTALLER TO FOLLOW:

- The National Fuel Gas Code, ANSIZ 223.1 /NFPA 54, ANSI STD Z21.58,-2022 CSA STD 1.6 -2022
- The National Electrical Code, ANSI/NFPA 70

SUPPLY PRESSURE MIN/

Liquid Propane Gas:	Natural Gas:
Supply Pressure:	Supply Pressure:
Minimum: 8” W.C. 1.99 kPa	Minimum: 3.5” W.C. .87 kPa
Nominal: 11” W.C. 2.73 kPa	Nominal: 7” W.C. 1.74 kPa
Maximum: 14” W.C. 3.48 kPa	Maximum: 14” W.C. 3.48 kPa

California Prop 65 Warning

WARNING: This product can expose you to chemicals including Lead and Lead Compounds, which are known to the state of California to cause cancer, and Carbon Monoxide, Lead and Lead Compounds which are known to the state of California to cause birth defects or other reproductive harm. For more information go to www.P65Warnings.ca.gov.

Removing Carter Pins

DIAMOND SERIES - Carter Pins

Your DIAMOND SERIES has carter pins VENTILATION on each burner. The carter pins are located at the rear of the grill. See Fig-

When Should I remove the Carter Pins?

1. If you are going to use PROPANE as your fuel source. You will need to remove all the burners to replace the orifice.
2. If you are going to be cleaning the burners - annually

Do I need to have the carter pins on my burners?

DIAMOND GRILL BBQ recommends you have them installed - but they are not needed. We put them on to secure the burners while we ship to your location.

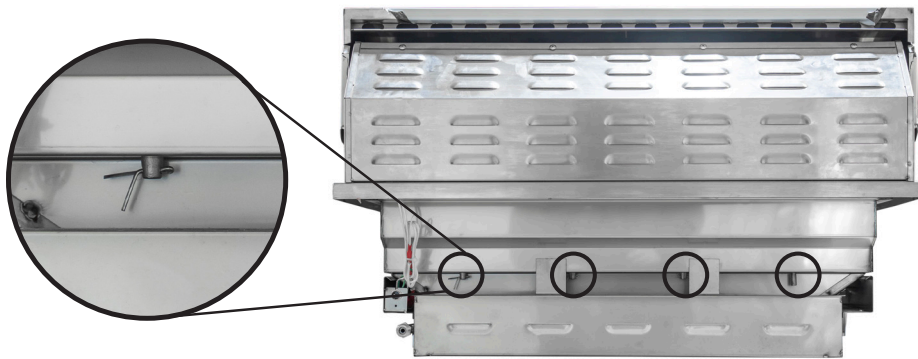

36" DIAMOND SERIES (4 Burner Grill)
- 4 Carter Pins

42" DIAMOND SERIES (5 Burner Grill)
- 5 Carter Pins

How To Remove CARTER PINS?

Use a pair of needle nose pliers to remove the carter pin.



PRO TIP:

Before installing your DIAMOND SERIES on the BBQ Island, remove the CARTER PINS while it is on the floor; it will be much easier to move around.

⚠️ DIAMOND SERIES - FOR PROPANE USE ONLY ⚠️

If you are going to use your DIAMOND SERIES with propane, make sure you follow the steps on how to switch to PROPANE ORIFICE.

How to replace NG ORIFICE to LP ORIFICE:

These steps ONLY APPLY if you are going to use PROPANE as your fuel source.



Remove Cooking Grates



Remove Flame Tamers



Remove Burners

How to replace NG ORIFICE to LP ORIFICE

How to replace NG ORIFICE to LP ORIFICE (Version 1 - While It sits on the BBQ Island):

If your DIAMOND SERIES GRILL is on the BBQ ISLAND, use these steps to replace the NG ORIFICE to LP ORIFICE.

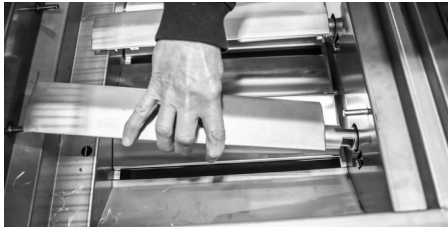

Make sure you have removed the **CARTER PINS**. Pull & Lift the **BURNER**.



Once you removed the **BURNERS** - Use a (5/16" (8mm) Socket) to take out the **NG ORIFICE**.

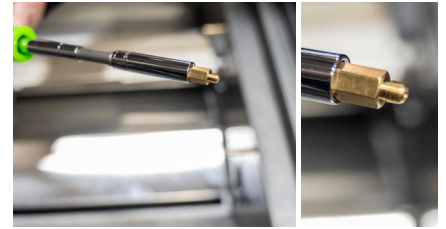

Take out all the **NG ORIFICES** and replace them with the **LP ORIFICE** - provided with the **DIAMOND SERIES**

How to replace NG ORIFICE to LP ORIFICE (Version 2 - Grill has not been installed on the BBQ ISLAND) [RECOMMENDED]

If your DIAMOND SERIES has not been installed yet on your BBQ ISLAND - use these steps to replace the NG ORIFICE to LP ORIFICE.

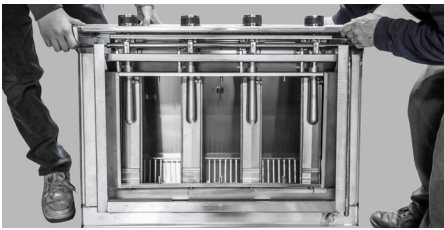

Get help from another person - flip the grill so the knobs are facing up.



With a needle nose plier remove the **CARTER PINS** from all the **BURNERS**



Lift & Pull all the **BURNERS** - they will easily come out.

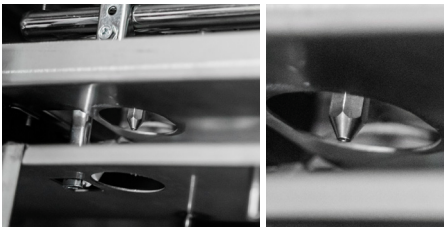

Once the **BURNER** is removed - located on the top of base is a brass **NG ORIFICE**.



Use a (1/4" Socket) to take out the **NG Orifice**. Replace all **ORIFICES** with an **LP ORIFICE** Provided with your **DIAMOND SERIES**.



Once you have added replaced the all the **NG ORIFICE** to **LP ORIFICE** - put back the **BURNERS**.

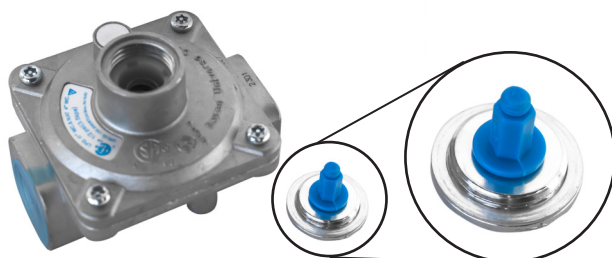

Natural Gas Ready

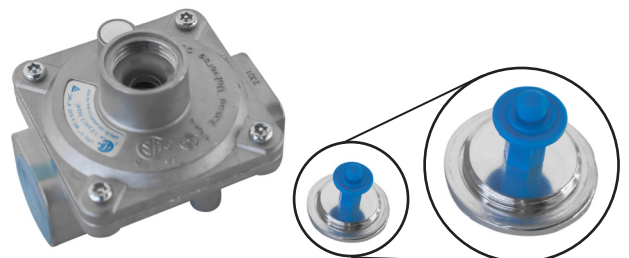

Propane Ready

How to install the REGULATOR

Natural Gas to Liquid Propane

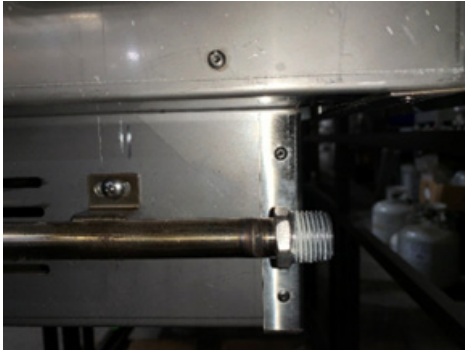

Step 1:
Locate manifold pipe, left side below the grill.

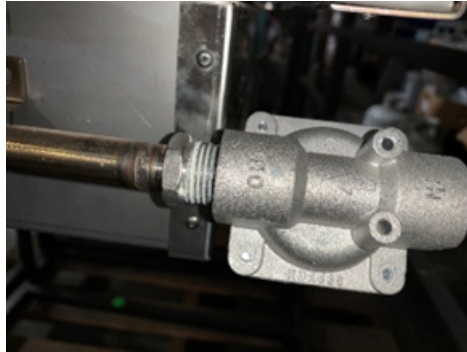

Step 2:
NG gas, attach regulator, note gas flow "IN" - "OUT."



Step 3:
LP gas "Hard Plumbed" conversion. Unscrew regulator cap.

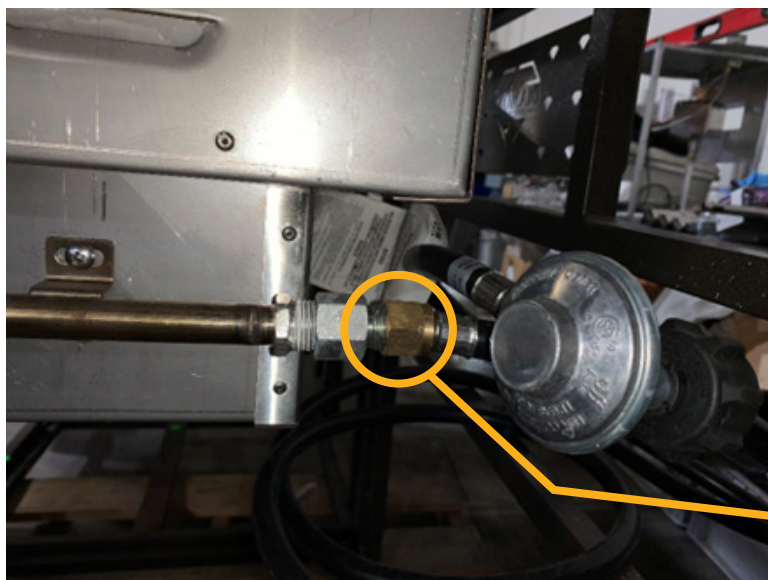
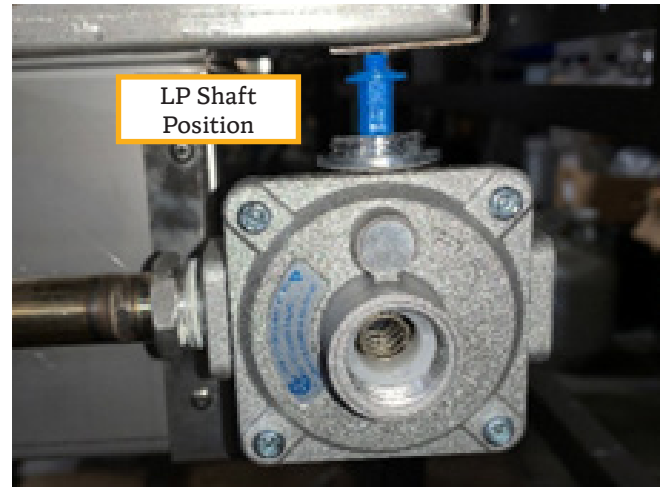
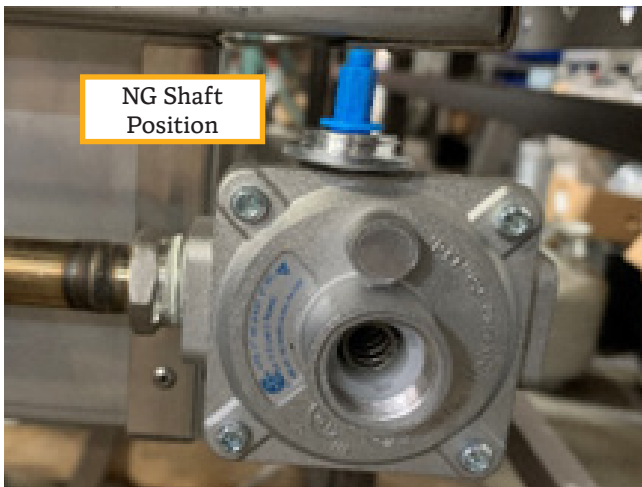

LP hose with Regulator Attachment

Attach 1/2" O.D flare with 1/2" FIP to manifold pipe. Attach regulator hose.

How to replace INFRARED ORIFICE

How to replace INFRARED ORIFICE (BACK)

If your **DIAMOND SERIES** comes equipped with our **DIAMOND INFRARED BURNER** attached in the **BACK PANEL** and you are going to use Propane - use these steps to replace the **NG ORIFICE** to a **LP ORIFICE**.



First, remove the five (5) Philip head's screws from the **BACK PANEL**. Use a Philips Head Screw Driver.

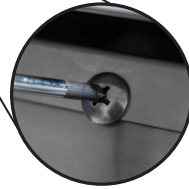

PRO TIP:

Before Installing your **DIAMOND SERIES** on the your BBQ Island, replace all the needed **ORIFICES** while it sits on the floor.

How to replace INFRARED ORIFICE (FRONT-INTERIOR)

Open your **42" DIAMOND SERIES** it has our **DIAMOND INFRARED BURNER** attached to the **BACK PANEL**. The Orifice is located in between the panels. You will need to remove.

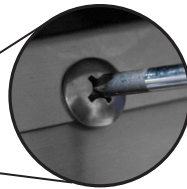
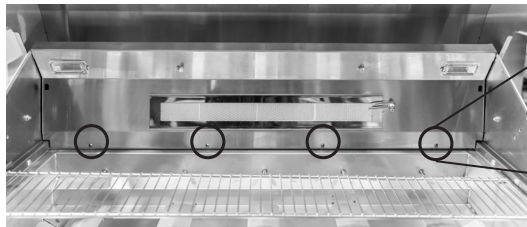

Remove the four (4) bottom screws located in the front, underneath the **DIAMOND INFRARED BURNER**. Use a Philip's head screwdriver.



Loosen the **RIGHT and LEFT HOOD SCREW** - this will allow the **PANEL** to easily come off when you pull.



To remove the **PANEL** - Lift up & pull the panel.

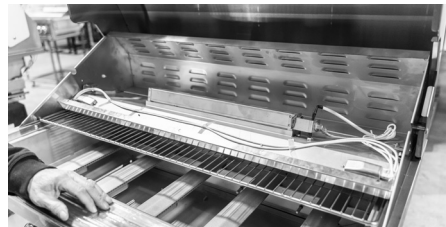

Make sure the **PANEL** sits flat, this will allow for easier installation of the **LP ORIFICE**.

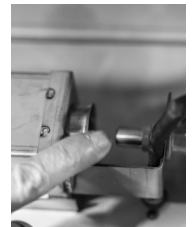

Locate the **NG ORIFICE** - it is behind the **DIAMOND INFRARED BURNER**.



Use a (9/16" (14mm)) Wrench - to replace the **NG ORIFICE** for the **LP ORIFICE**.



Once you replaced the **NG ORIFICE** with the **LP ORIFICE**. Put back the **PANEL**.



Re-tighten **RIGHT and LEFT HOOD SCREW**.

How to replace INFRARED ORIFICE

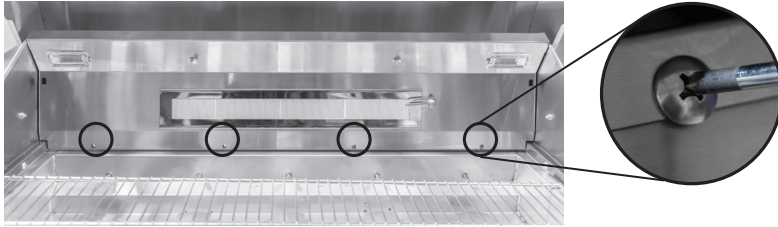

Reinsert the four (4) screw from you took out. Located in the Interior of the grill underneath the **DIAMOND INFRARED BURNER**.

NOTE:

Once you have replaced the orifices mark your rating plate from NG to LP fuel type.

		<small>36" DIAMOND SERIES BY DIAMOND GRILLS BBQ 701 S DUPONT AVE. ONTARIO, CA 91761 PHONE: 909-460-5579 EMAIL: SUPPORT@DIAMONDGRILLSBBQ.COM</small>			 00000000 CONFORMS TO ANSI STD Z21.58-2002 CERTIFIED TO CSA STD 14-2002
		MODEL NO:	GAS TYPE:	BURNER BTU:	
<input type="checkbox"/>	DG-4B36-LP	PROPANE	15,000	60,000	1.57mm
<input type="checkbox"/>	DG-4B36-NG	NATURAL GAS	15,000	60,000	1.70mm
SERIAL NO: <input type="text"/>					
Outdoor Cooking Gas Appliance Manufactured By The Outdoor Plus					
					4 BURNER GRILL RATING PLATE 120V, 60Hz < 1AMP

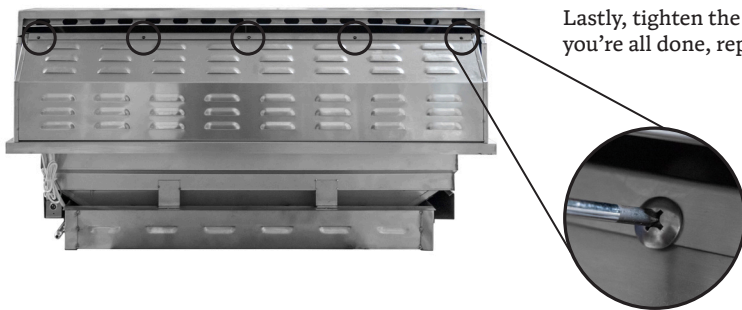

Lastly, tighten the five (5) screws from the back panel. Once you have finished - you're all done, replacing the NG ORIFICE to LP ORIFICE.

PRO TIP:

Before Installing your **DIAMOND SERIES** on the BBQ Island, remove the **CARTER PINS** while it is on the floor, it will be much easier to move around.

How to replace a burner for our High-Performance Infrared Burner

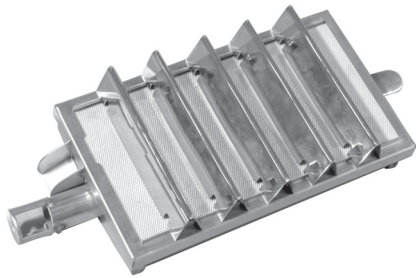

High-Performance Infrared Burner:

If you bought our **HIGH-PERFORMANCE INFRARED BURNER**, follow these steps to learn How To replace your current burner with our Infrared Burner.

PRO TIP:

Most **INFRARED BURNER** are placed on the edge of the grill - consider Installing the Infrared Burner on the Left or Right of the **DIAMOND SERIES**.

How to switch to Propane Orifice (Version 1 - While It sits on the BBQ Island):

If your **DIAMOND SERIES GRILL** is on the **BBQ ISLAND**, use these steps to replace the NG ORIFICE to LP ORIFICE.

How To Replace your current BURNER with our DIAMOND SERIES INFRARED BURNER.

Choose which side the **INFRARED BURNER** will be located and remove the **CARTER PIN**. See page 7. Follow the steps to remove the **CARTER PINS**.

36" DIAMOND SERIES (4 Burner Grill)

- 4 Carter Pins

42" DIAMOND SERIES (5 Burner Grill)

- 5 Carter Pins

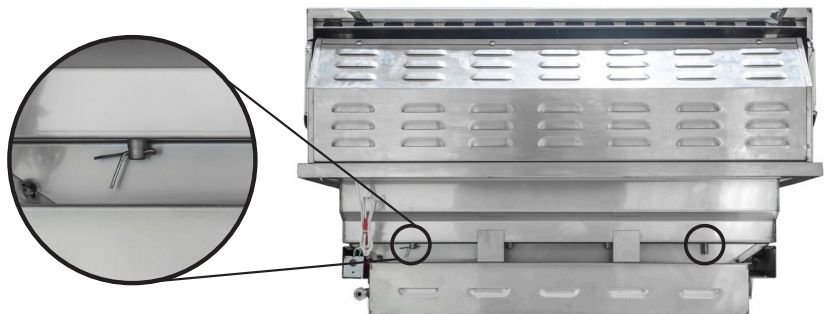

How to replace a burner for our High-Performance Infrared Burner

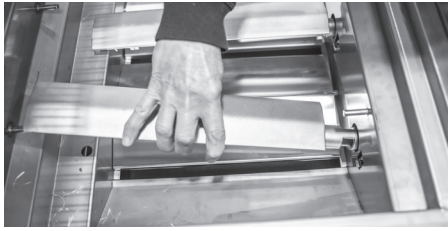

Make sure you have removed the **CARTER PINS**. Pull & Lift the **BURNER**.



Once the **BURNER** has been removed - place the **HIGH-PERFORMANCE INFRARED BURNER** in it's place. Make Sure you put back the **CARTER PIN** to secure the **HIGH-PERFORMANCE INFRARED BURNER**.

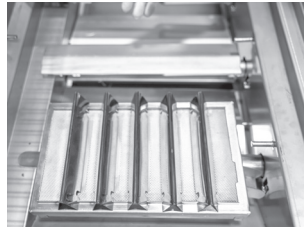

ATTENTION:

If you are using PROPANE - See Page 7, to learn how to replace your **NG ORIFICE** to **LP ORIFICE**.

Burner Knob - Information

36" DIAMOND SERIES - 4 Burner

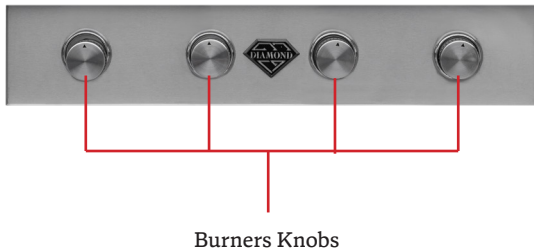

Burners Knobs

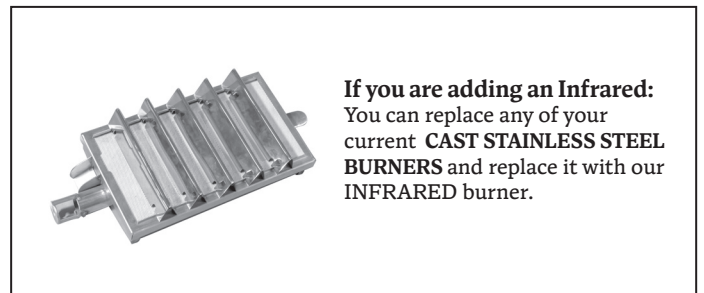

42" DIAMOND SERIES - 5 Burner

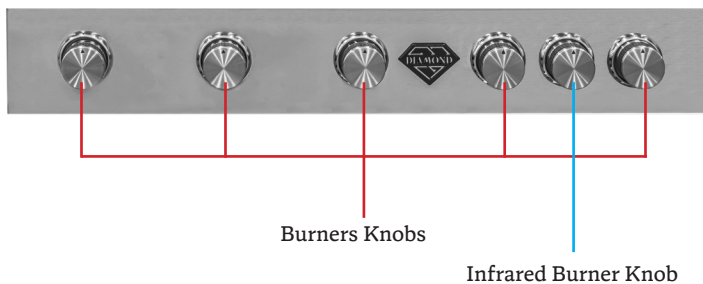

Burners Knobs

Infrared Burner Knob

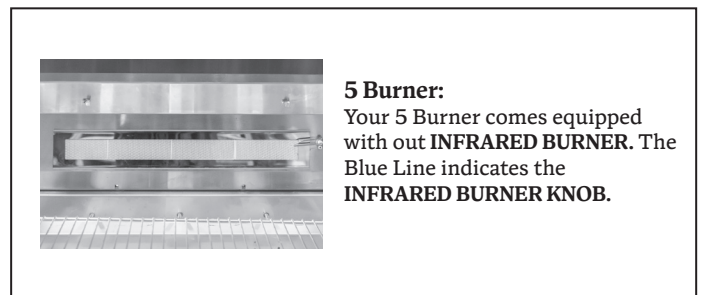

4 Burner - Specifications

PART NO.	PRODUCT NAME
1.	Anti-Rotation Handle & Lock
2.	Cooling Handle
3.	Hood Insulator
4.	Thermometer
5.	Adjustable Warming Rack
6.	Cool To Touch Silicone Knob
7.	Full Grease Tray
8.	304 Stainless Steel Construction
9.	Back Panel
10.	Double Line Hood
11.	Grill Lights
12.	Cooking Grates
13.	Rotisserie Station

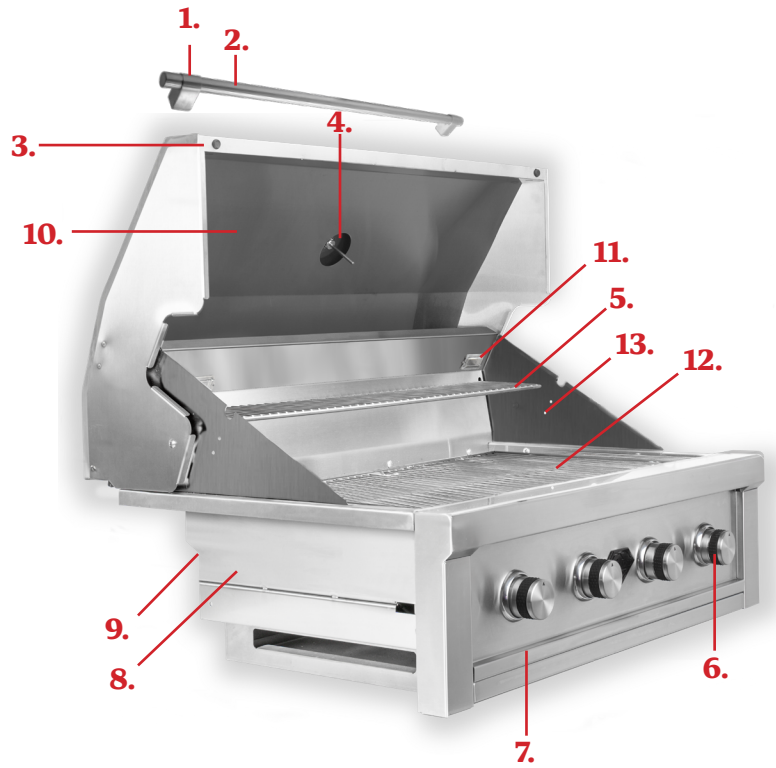

Replacement Parts



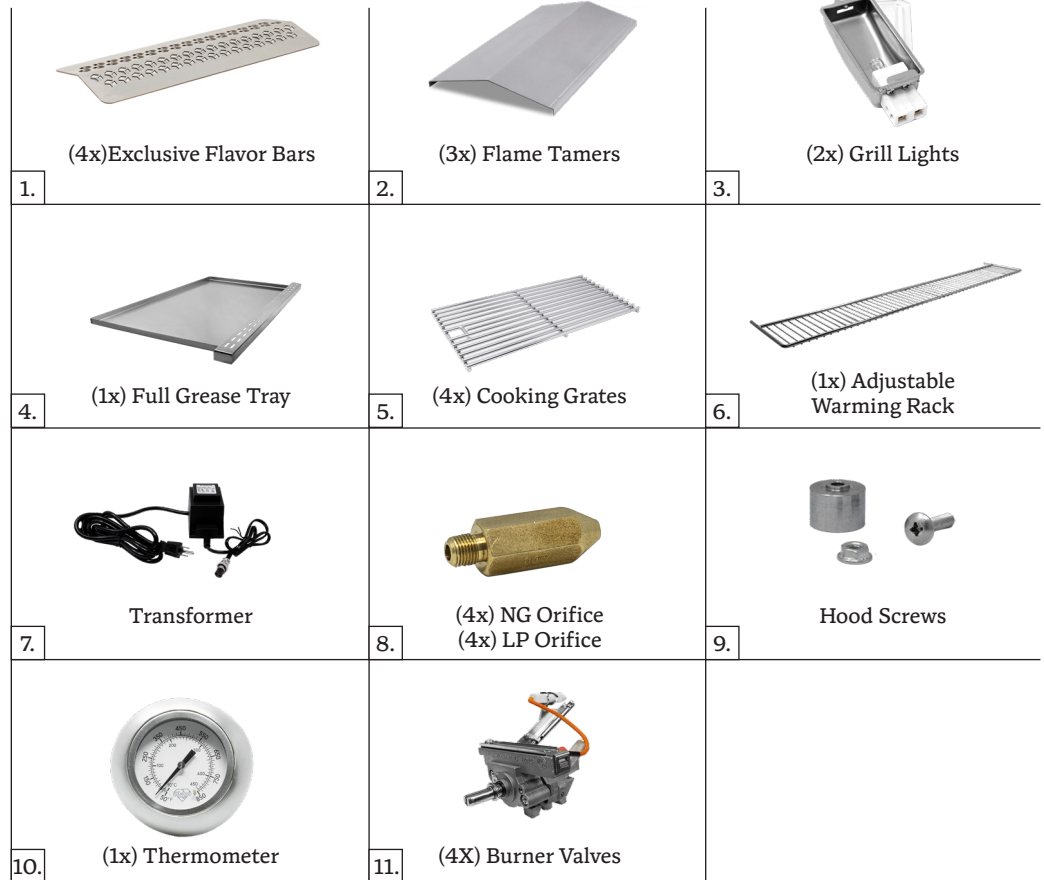





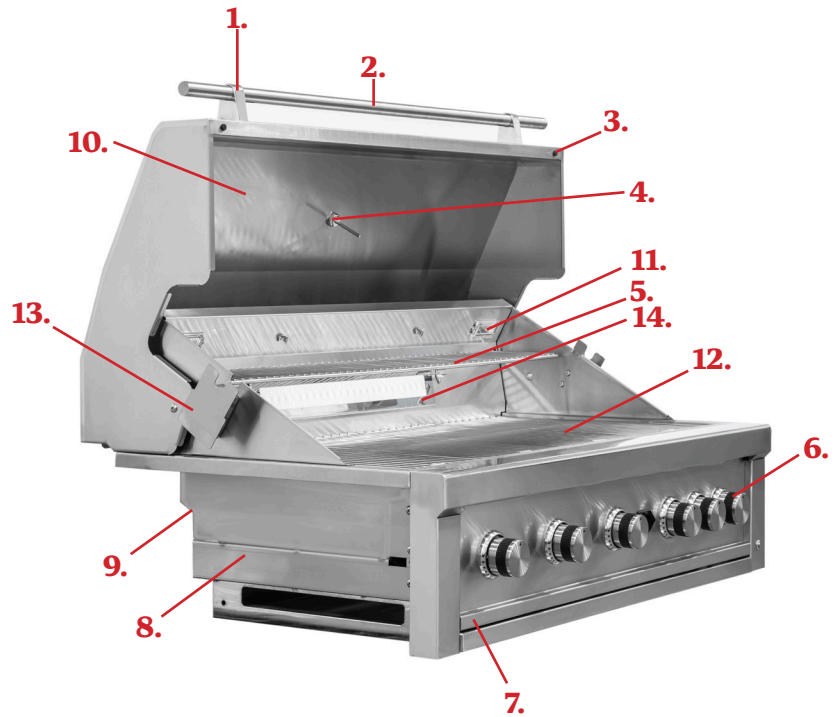

1. DG-FBAR
2. DG-FTAM
3. DG-GLIGHT
4. DG-36GTRAY
5. DG-36CGRATE
6. DG-36WRACK
7. DG-TRFMR
8. DG-LPO | DG-NGO
9. DG-HSCREW
10. DG-THERMO
11. DG-36VALVE

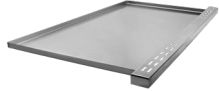

5 Burner Plus - Specifications

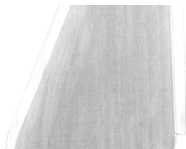
PART NO.	PRODUCT NAME
1.	Anti-Rotation Handle & Lock
2.	Cooling Handle
3.	Hood Insulator
4.	Thermometer
5.	Adjustable Warming Rack
6.	Cool To Touch Silicone Knob
7.	Full Grease Tray
8.	304 Stainless Steel Construction
9.	Back Panel
10.	Double Line Hood
11.	Grill Lights
12.	Cooking Grates
13.	Rotisserie Station
14.	Infrared Burner



 (5x) Exclusive Flavor Bars 1.	 (4x) Flame Tamers 2.	 (2x) Grill Lights 3.	 (1x) Full Grease Tray 4.
 (5x) Cooking Grates 5.	 (1x) Adjustable Warming Rack 6.	 Transformer 7.	 (5x) NG Orifice (5x) LP Orifice 8.
 Hood Screws 9.	 (1x) Thermometer 10.	 (5X) Burner Valves 11.	 Infrared Orifice 12.

Replacement Parts

1. DG-FBAR	6. DG-WRACK	11. DG-VALVE
2. DG-FTAM	7. DG-TRFMR	12. DG-IRETOR
3. DG-GLIGHT	8. DG-LPO DG-NGO	
4. DG-GTRAY	9. DG-HSCREW	
5. DG-CGRATE	10. DG-THERMO	

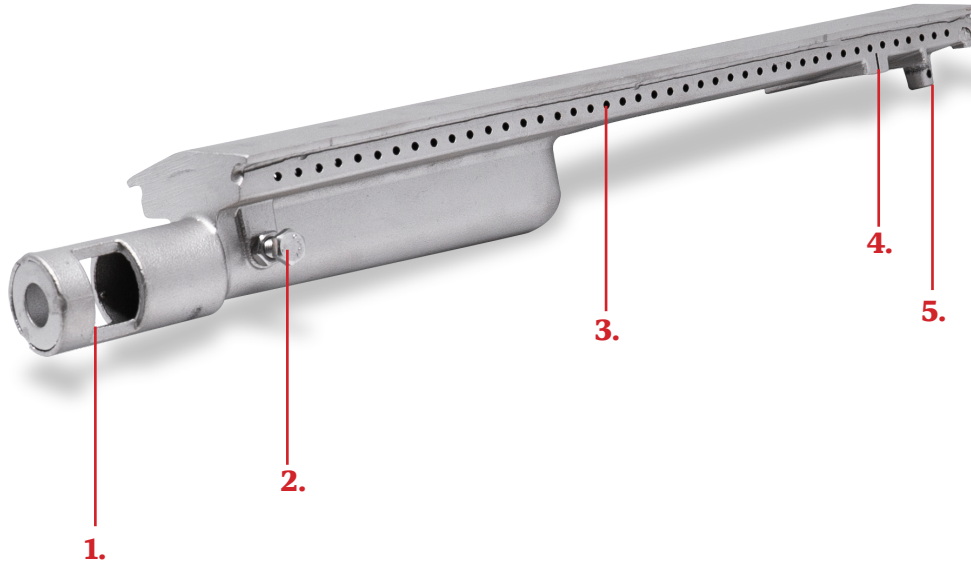

Cast Stainless Steel Burner with Flame Runner DG-CSTBURNER

- 1. Air Venturi
- 2. Air Adjustment Screw
- 3. Flame Ports
- 4. Flame Runner
- 5. Burner Pin Lock

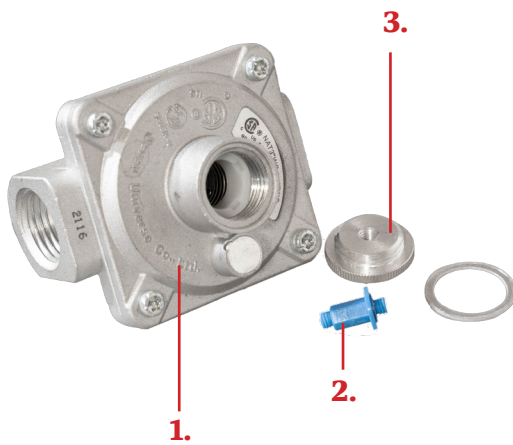

Convertible Gas Regulator DG-RGUTR

- 1. Convertible Regulator
- 2. Stem Cap
- 3. Regulator Cap

Grill Location

Your grill has a lip that rests on top of the counter edge around the cut-out with the front of grill which is Free-Hanging from Counter top. Because of this, there is No Need for any Trim-Kit like with many other grills in the market.

1. Maintain 24" Clearance from any Combustible Materials in ANY direction of Grill.
2. If any combustible materials within 24" distance, must have Heat Barrier like Grill Jacket, or other Non-Combustible type like Bricks, Hardy Board, Metal.
3. Orient the grill so the Prevailing winds are not blowing into the rear or side of grill.

⚠ WARNING: Never build shelf or enclose interior space under the BBQ Cut-Out. The Diamond Grill Series is supported by the top counter surface on the Back and Sides, the front of grill is designed to Free-Hang. The bottom of Grill needs to be open to allow for proper ventilation.



Figure: 1A

Figure: 1A

1. Interlocking Front Panel, is designed to sit flush against the island face. The face grill so prevailing wind is directed towards front of the grill.
2. Cooling Handle, is designed to keep heat out of the handle while the grill is in use. Cold air is brought inside the handle making it cool to touch through out the entire time you are using the grill.
3. The grill is specially designed with an internal built in hanger lip located at the right, left and back sides. The grill lip allows it to hang by the three supported edges on the right, left and back. The front control panel requires no supporting edge; it is designed to hand down the front of your cut-out.

Windy Conditions

Your grill is specially designed to draw fresh air in through the front, and in direct to the bottom burners. When grilling the hot gases are then released through the back of grill through a venting system. Using your grill in windy conditions may disrupt the front-to-back air flow.

Grill Location

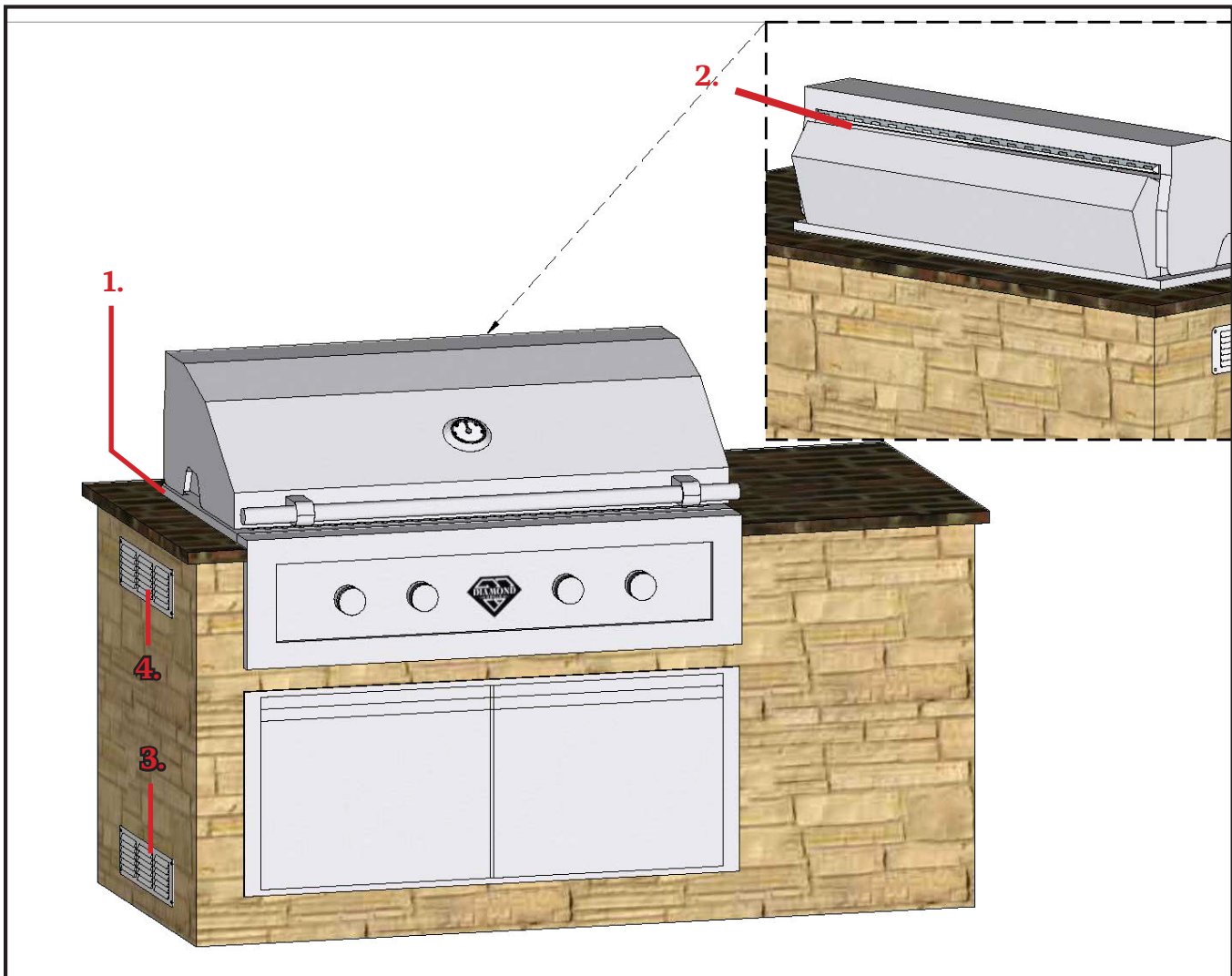

Figure: 1B

Figure: 1B

1. Diamond Grill BBQ has been designed to easily be placed on top of your BBQ Island cut outs.
2. Your Diamond Grill should be placed where air is coming in from the front or bottom.

⚠ WARNING: DO NOT SEAL BBQ, DOORS, DRAWERS, BBQ ISLAND ACCESSORIES WITH ACRYLIC, POLYURETHANE, EPOXY OR ANY TYPE OF SEALANT. ADDING A SEAL CAN CAUSE FUEL TO BUILD UP AND CAUSE AN EXPLOSION.

3. If you are going to use PROPANE GAS, place Air Vents in the bottom of your BBQ Islands - Propane Gas is heavy and sits low to the ground.
4. If you are going to use NATURAL, place Air Vents at the TOP of your BBQ Islands - Natural Gas is lighter and rises.

⚠ ATTENTION: IF YOU BUILDING THE BBQ ISLAND, REMEMBER TO ADD PROPER AIR VENTILATION. ALWAYS ADD CROSS VENTILATION ON YOUR BBQ ISLAND.

Grill Location

Installing into windy open areas

Positioning your grill in your backyard is more often thought of how it is pleasing to the eye, but more important than this is how that it functions correctly. Unlike an indoor appliance, your grill must combat many outside weather influences in an all manner of weather-related instances, most severely is Wind.

⚠ WARNING: NEVER BUILD YOUR OUTDOOR KITCHEN ISLAND USING COMBUSTIBLE MATERIALS, MAINTAIN 24" DISTANCES FROM GRILL. USING A GRILL JACKET IS NOT A SURE BET TO PROTECT COMBUSTIBLE MATERIALS.

⚠ ATTENTION: Take special precaution when installing grill in open Breezy area, check the direction of Prevailing Wind, if back of grill is facing any oncoming wind or breeze, be sure to protect the back of grill, and erect a partition wall, or only use grill with hood open on breezy days.



Figure: 1C

Figure: 1C

1. Maintain proper Prevailing wind, grill direction – with the front of grill facing in to the wind.
2. If direction of wind is unclear, or difficult to combat even with preventative measures, then always grill with the hood open, and when hood is closed – always be within proximity to grill and monitor it that it does not overheat.
3. If wind or breeze is in the direction of back of grill, you must erect partition wall of 14" height so that the top of grill hood is covered by several inches. If this is not done, you must grill with hood open and or when hood is closed stand in close area to grill and monitor if the grill overheats.

⚠ WARNING: THIS OUTDOOR COOKING APPLIANCE IS NOT APPROVED TO BE INSTALLED IN OR ON ANY RECREATIONAL VEHICLES AND/OR BOATS. DIAMOND SERIES IS FOR SINGLE FAMILY/RESIDENTIAL USE ONLY.

Grill Location

Outdoor Structure Definition

Structure built above Appliance that is sometimes attached to the home's exterior outside wall or roof and there is a Minimum of "Two" adjacent sides which are open with outside exposure.

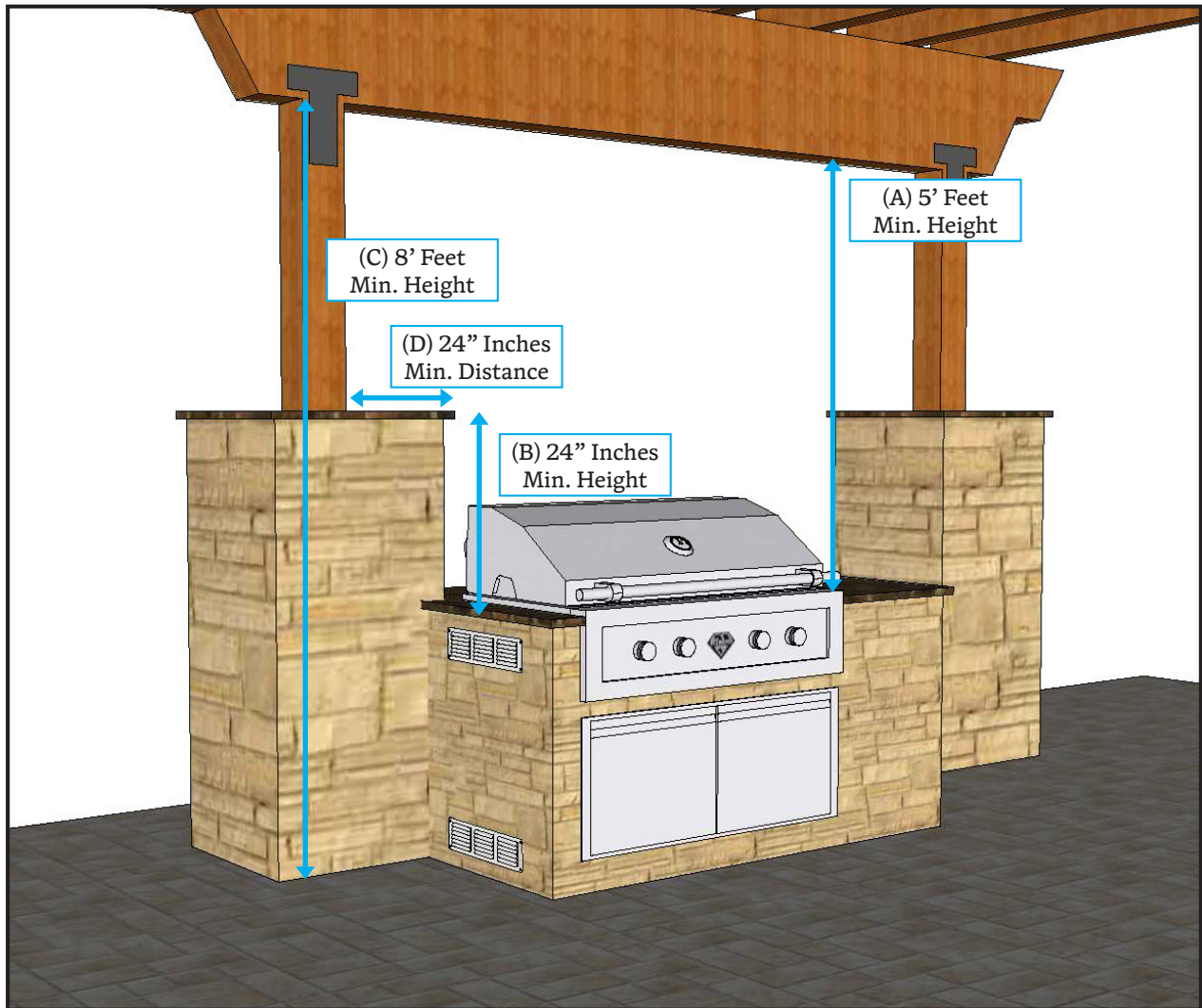

Figure: 1D

Minimum Distances to Combustible Materials or other Appliance Only.

A. From Counter to Overhead Structure	5' Feet Min. Clearance
B. From Counter to Combustible Material "if" within 24" distance	24" Min. Clearance
C. From Floor to Underside of Overhead Structure	8' Feet Min. Clearance
D. From Appliance to Combustible Material	24" Min. Clearance

⚠ WARNING: THE GRILL NEEDS TO BE OPEN TO ALLOW FOR PROPER VENTILATION: ALLOW 2 INCHES OF MINIMUM CLEARANCE/VENTILATION AT THE BOTTOM OF THE ENCLOSURE.

Grill Location

Installing into an Enclosed Area

ENCLOSED ISLAND DEFINITION:

Any Appliance that is installed into “Enclosed” structure with Two or more sides walled off, either into an outdoor home’s patio structure, against any home exterior wall or under any Eaves of the home.

CLEARANCES TO NON-COMBUSTIBLE CONSTRUCTION:

A minimum of 24” clearance from non-combustible construction is required for the purpose of allowing the lid to open fully. If you’ll be using the rotisserie option, the space is essential for motor and skewer clearance.

CLEARANCES TO COMBUSTIBLE CONSTRUCTION:

Minimum of 24” from the sides and rear of grill must be maintained to adjacent vertical combustible construction, above the counter top level. You should take in account that there is a large volume of heat, and smoke will exhaust from the rear of the grill. This may discolor or damage unprotected areas, do not install under unprotected combustible construction without using a fire safe ventilation system.

A 24” minimum clearance must be maintained under the counter top to combustible construction. The clearance can be modified by a use of an insulated jacket.

DEFINITION OF COMBUSTIBLE MATERIAL:

Any materials of a building structure or decorative structure made of wood, compressed paper, plant fibers, vinyl/plastic or other materials that are capable of transferring heat or being ignited and burned. Such material shall be considered combustible even though flame- proofed, fire-retardant treated or surface-painted, or plastered.

 **ATTENTION:** All Gas Grill Island Installations MUST HAVE MINIMUM TWO AIR-FLOW VENTS, either in ELEVATED POSITION for Natural Gas or LOWERED POSITION for Liquid Propane. Your Warranty may be VOID if island does not meet basic setup requirements.

 **ATTENTION:** BODILY INJURY: Failure to maintain required clearances creates a fire hazard that may result in property damage or serious personal injury.

 **WARNING:** NEVER BUILD YOUR OUTDOOR KITCHEN ISLAND USING COMBUSTIBLE MATERIALS, MAINTENANCE 24” DISTANCES FROM GRILL.

 **WARNING:** THIS OUTDOOR COOKING APPLIANCE IS NOT APPROVED TO BE INSTALLED IN OR ON ANY RECREATIONAL VEHICLES AND/OR BOATS. DIAMOND SERIES IS FOR SINGLE FAMILY/RESIDENTIAL USE ONLY.

Proper Ventilation: Ensure there is adequate ventiaction for the gas appliance and/or island. This is required to prevent gas built-up. Keep the ventilation openings of the enclourses free and clear from any debris.

Connecting The Transformer

Locate The Transformer



Figure: 2A

Figure: 2A

Remove the transformer from the plastic bag located in the interior of grill. Make sure the Transformer is complete, and Double check the grill light plug cord is properly secured to transformer, and all wires are firmly fixed into plastic clip plug.

Locate The Transformer Grill Connection

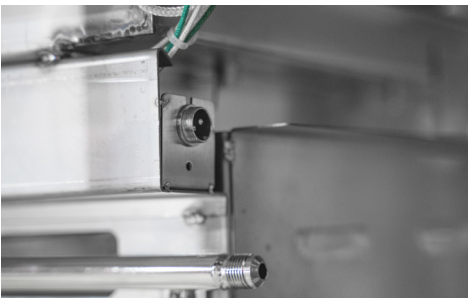

Figure: 2B

Figure: 2B

The Grill transformer connection is located in the rear of the grill, right above the gas connection.

Make Connections

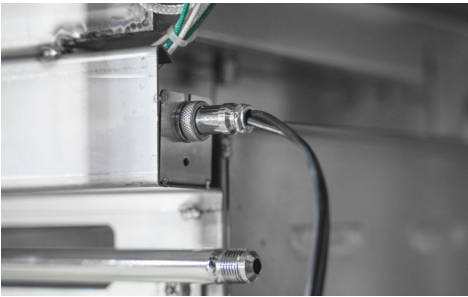

Figure: 4C

Figure: 4C

Connect the pin connector to the grill, and tighten it securely.

⚠ ATTENTION: Use only with GFI protected circuit.

⚠ ATTENTION: Use only extension cord approved for outdoor use marked with W-A, and rated for the power of this appliance.

Propane Information

Types of Propane Tanks:

Propane tanks are mainly used alongside stoves, water heaters, grills, generators, and welding equipment. These bottles or metal cylinders contain propane, a type of alkaline gas that has been compressed and transformed into liquid form. Transporting, storing, and using propane safely can only be possible if it is held inside tanks or containers. Since propane has various applications, many types of tanks are being used as propane containers. Below are some common examples.

Large Capacity Tanks:

Propane is delivered to your home as a very cold liquid and is pumped into a specially designed storage tank (Fig.A). The liquid changes to gas before leave's the tank. Propane tanks are typically painted white or silver to reflect heat and prevent the pressure inside the tank from getting too high.

If you have an underground tank, only the cover (Fig.B) will be visible above ground.

1. The cover on top of the tank protects several components from weather and physical damage.
2. The tank shut-off valve, which you can close to stop the flow of propane to your home in case of a leak or other emergency.
3. The regulator, which controls the pressure of the propane gas coming out of the tank.
4. The safety relief valve, which will pop open automatically if the pressure inside the tank gets too high.
5. The valve will close again when the pressure returns to normal.
6. The tank gauge, which shows the percentage of propane in the

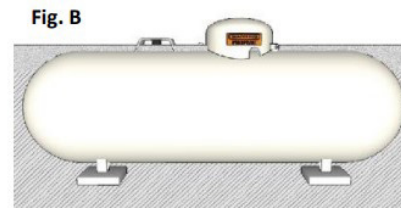

Propane flows from your tank to your home through pipes, most of which run underground. You may also have a secondary pressure regulator on an outside wall of your home to further adjust gas pressure. A shut-off valve in each pipe can be closed to stop gas flow to an individual appliance. An appliance connector is the final segment in the gas piping system. This specially designed flexible tube typically two or three feet long-carries gas from a pipe to the back of an appliance.

Medium Capacity Tanks:

Any L.P. Gas supply cylinder used with this grill must be approximately 12 inches diameter and 18 inches high. The maximum fuel capacity is 80% and is approximately 20 pounds of propane. The L.P. Cylinder must have a shut-off valve terminating in a Type 1 L.P. A Type 1 compatible cylinder with a Type 1-cylinder valve has a back-check valve which does not permit gas flow, until a positive seal has been obtained.

LP Tank Filling:

- Use only licensed and experienced dealers.
- LP dealer must purge tank before filling.
- Dealer should NEVER fill LP tank more than 80% of LP tank volume. Volume of propane in tank will vary by temperature.
- A frosty regulator indicates gas overfill. Immediately close LP tank valve and call local LP gas dealer for assistance.
- Do not release liquid propane (LP) gas into the atmosphere. This is a hazardous practice.
- To remove gas from LP tank, contact an LP dealer or call a local fire department for assistance.
- Check the telephone directory under "Gas companies" for nearest certified LP dealers.

Propane Information

⚠ WARNING: : If you have a Side Yard Propane Tank, you **MUST** have additional Medium Pressure Regulator located at the Grill. If you do not serious bodily harm may result or damage to the grill and island structure from HIGH Heat extremes.

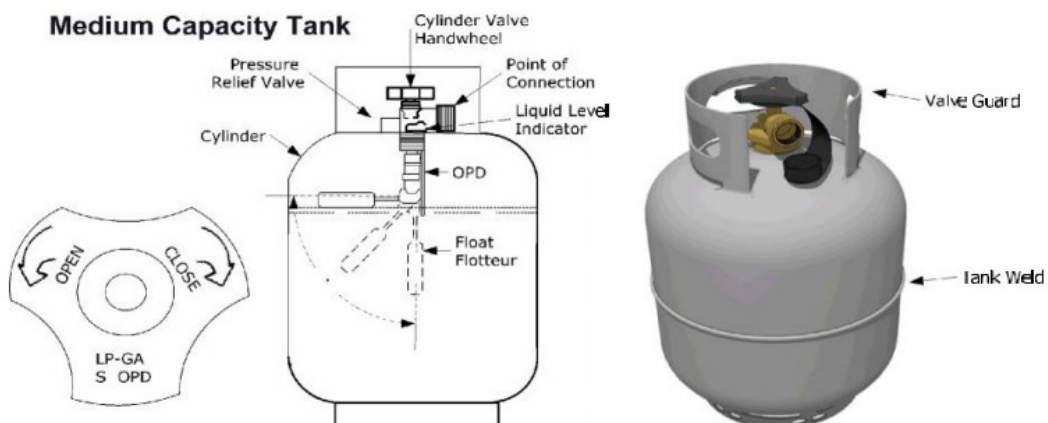
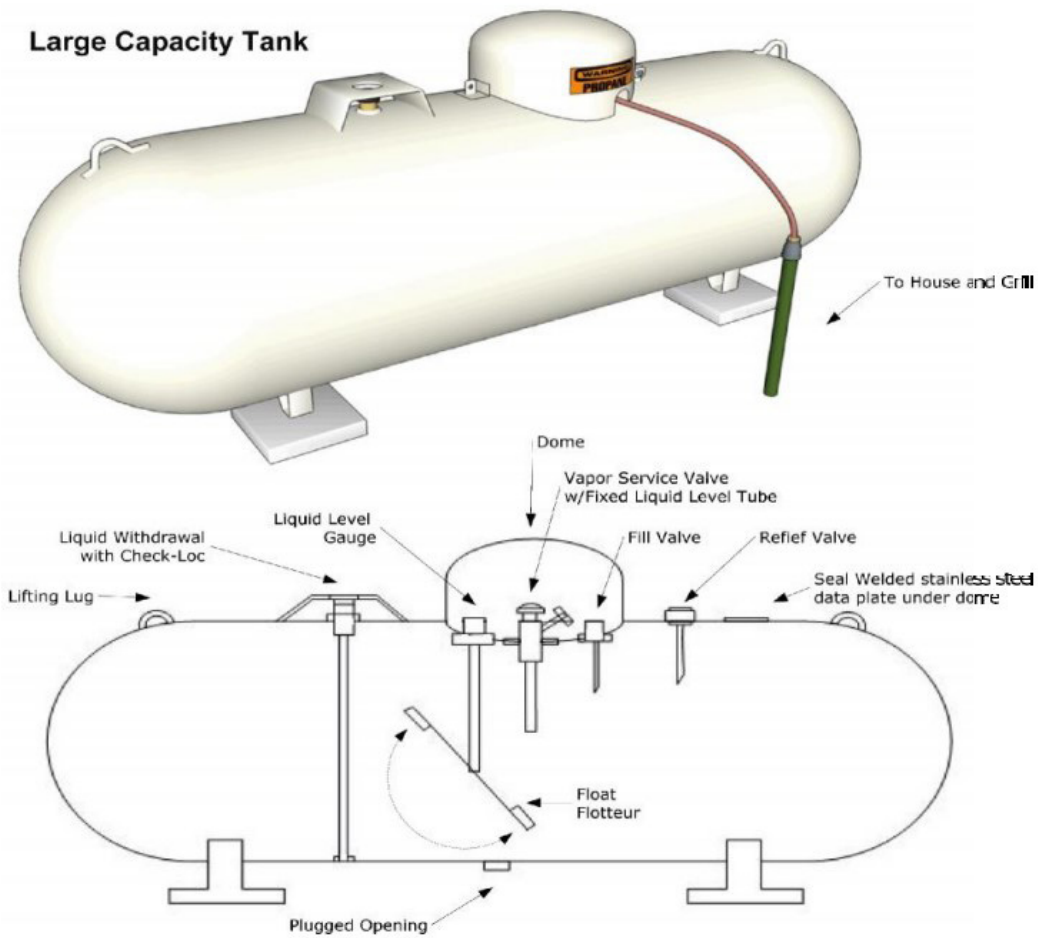

GRILL INSTALLATION

PROPANE TANK CONNECTION

IMPORTANT: Before connecting grill to gas source, make sure BBQ Grill control knobs are in “OFF” Position. Verify the type of gas supply to be used, either natural or LP.

NOTE: GRILLS ARE SHIPPED IN NG

All pipe sealants must be an approved type and resistant to the actions of LP gas. Never use pipe sealant on flare fittings. The installation of this appliance must conform with local codes or, in the absence of Local codes, with either National Fuel Gas Code, ANSI Z223.1/ NFPA 54, Natural Gas and Propane Installation Code, CSA B149.1, or Propane Storage and Handling Code, B149.2, or the Standard for Recreational Vehicles, ANSI A 119.2/ NFPA 1192M, and CSA Z240 RV Series, Recreational Vehicle Code, as applicable.

LP Tank Removal, Transport and Storage

- Turn OFF all control knobs and LP tank valve. Turn coupling nut counterclockwise by hand only - do not use tools to disconnect. Lift LP tank wire upward off LP tank collar, then lift LP tank up and off of support bracket. Install safety cap onto LP tank valve. Always use cap and strap supplied with valve. Failure to use safety cap as directed may result in serious personal injury and/or Property damage.

- A disconnected LP tank in storage or being transported must have a safety cap installed. Do not store an LP tank in enclosed spaces such as a carport, garage, porch, covered patio or other building. Never leave a LP tank inside a vehicle which may become overheated by the sun.

The cylinder must be arranged for vapor withdrawal. It must also include a collar to protect the cylinder valve. A safety relief device having direct communication with the vapor space of cylinder must be Provided. This will expel high pressure gas if the cylinder is overfilled or overheated which could result in fire or explosion.

- All L.P. Gas cylinders used with this appliance shall be constructed and marked in accordance with the specifications for L.P. Gas cylinders of the U. S. Department of Transportation (DOT) or the National Standard of Canada, CAN/CSA-B339, Cylinders, Spheres and Tubes for Transportation of Dangerous Goods; and Commission, as applicable; and shall be provided with a listed overfilling prevention device.

- Read labels on the L.P. Gas Supply Cylinder.

- New cylinders are always shipped empty for safety.

- Allow only qualified L.P. Gas dealers to fill or repair your L.P. Gas supply cylinder.

- Inform the gas dealer if it is a new or used cylinder to be filled.

- After filling, have the gas dealer check for leaks and to see that the relief valve remains free to Function.

Propane Information

HOSE AND REGULATOR

The Type 1 connection system has the following features:

- The system will not allow gas to flow until a positive connection has been made.
- NOTE: The cylinder control valve must be turned off before any connection is made or removed. ☒ The system has a thermal element that will shut off the flow of gas in the event of a fire.
- The system has a flow limiting device which, when activated, will limit the flow of gas to 10 cubic feet per hour.
- NEVER use grill without leak testing.

Propane vapors are heavier than air. For this reason, they may accumulate in low-lying areas such as basements, crawl spaces, and ditches, or along floors. However, air currents can sometimes carry Propane vapors elsewhere within a building

LP GAS SUPPLY CONNECTION AND DISCONNECTION

1. The tank valve should be in the “OFF” position. If not, turn the knob clockwise until it stops.
2. Make sure all burner valves are in the “OFF” position.
3. Always connect the gas supply regulator as follows: Insert the regulator inlet into the tank valve and turn the coupling nut clockwise until the coupler tightens up. Do not over tighten the coupler. Turn the main tank valve on and turn the burner control valves on the unit to the “HIGH” position for about 10 seconds to allow the air in the system to purge before attempting to light the burners.

LP TANK DISCONNECTION

1. Turn the burner valves off.
2. Turn the tank valve off. (Turn clockwise to stop).
3. Detach the regulator assembly from the tank valve by turning them quick coupling nut Counterclockwise.

LP GAS HOOK UP

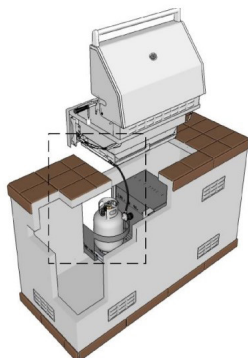

Figure: 6A

Figure: 6A

This liquid propane grill is designed to operate on Liquid Propane ONLY. The LP gas grill is designed to be used with a standard 20 lbs gas cylinder and must be constructed and marked in accordance with specifications of the US Department of Transportation for propane gas cylinders. Always keep cylinder securely fastened in an upright position. Never connect an unregulated propane gas cylinder to the grill. Do not subject propane cylinders to excessive heat.

⚠ CAUTION: It is recommended you use a Propane Tank Pull-Out Drawer. It is severely hazardous to move propane tanks in and out of Island enclosure without assistance of drawer.

Natural Gas Information

Natural Gas Safety:

Your **DIAMOND SERIES GRILL** is shipped as **NATURAL GAS** appliance.

Natural Gas Installation:

- It is recommended that your “**ON-OFF**” shutoff valve be installed at the gas supply source.
- When testing for gas leaks, turn off your **DIAMOND SERIES**.
- Provide adequate Ventilation Holes in the Enclosure for safety purposes in the event of a gas leak.
- Make sure the factory supplied **REGULATOR** is used on your **DIAMOND SERIES**.



Gas Convertible Regulator:

Your **DIAMOND SERIES** comes ready in **NATURAL GAS** - if you wish to convert your gas type please Follow the instruction on page 7.

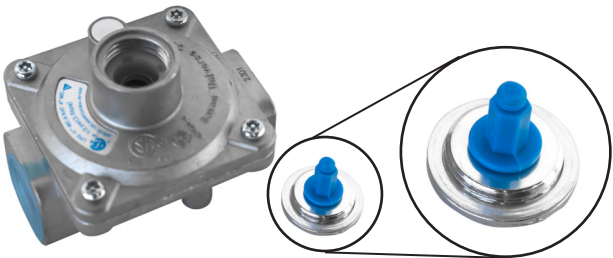

Natural Gas Ready

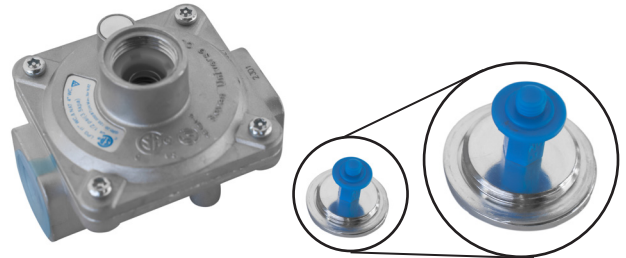

Propane Ready

⚠ WARNING: Gas valves are preset at the factory to operate on Propane and Natural Gas. If you wish to convert to a different gas type, be sure to contact your grill dealer, licensed plumber or authorized service center for further details. Failure to properly convert a unit can cause serious injury to yourself and/or others.

⚠ ATTENTION: Always turn grill knobs OFF, before installing gas lines, or making any Connections and disconnections of supply hoses.

⚠ WARNING: Always take a leak test before lighting the grill to prevent a possible fire or explosion.

Grill Start Up

Grill Start Up(Match Lit):

To light gas grill with a gas lighter, make sure the grill has been leak tested and burners be properly located. Insert long-necked gas lighter through the cooking grid, and in through an adjacent side port hole of the Flavor Bar, placing near a burner side. Turn the closest burner knob on to “HIGH” setting to release gas. Turn on the button on gas lighter, burner should light immediately. Adjust burners to desired cooking temperature.

1. Open Lid/Hood
2. Ensure Burner Control Knobs In the “OFF” position, Turn on the gas supply valve.
3. Push the burner knob in and slowly rotate counter-clockwise to the high position.
4. You will hear a loud click as the electronic lighter produces a spark. Listen for the sound of the gas igniting and look for a flame through the cooking grids. If the burner does not light on the first try, repeat immediately.
6. If the burner does not light in 5 seconds then wait five minutes until the gas clears before attempting to light it again. Repeat the procedure or try the manual lighting procedure below.
8. Upon successful lighting, repeat the process on the other burners you wish to light.
9. To shut off the burners, rotate the knob and turn to OFF.
10. It is normal to hear a popping sound when the burners are turned off.

Grill Start Up (Valve Ignition):

When lighting the grill, please keep your face and body away from the grill top when lighting the grill.

1. Open Lid/Hood, do not attempt to ignite the burners while the hood is closed.
2. Make sure your gas supply is turned on & the Burner Control Knobs are in the “OFF” position.
3. Push the burner knob in and slowly rotate counter-clockwise to the high position.
4. You will hear a loud click as the electronic lighter produces a spark. Listen for the sound of the gas igniting and look for a flame through the cooking grids. If the burner does not light on the first try, repeat immediately.
6. If the burner does not light in 5 seconds then wait five minutes until the gas clears before attempting to light it again. Repeat the procedure or try the manual lighting procedure below.
8. After ignition, set the knob to the desired setting.
9. To shut off the burners, rotate the knob and turn to OFF.
10. It is normal to hear a popping sound when the burners are turned off.

LIGHTING INSTRUCTIONS:

DO NOT use indoors - this gas appliance is intended to be used for OUTDOOR USE ONLY! Your surroundings should be kept clean and free from flammable combustible materials



**KNOB POSITION:
OFF**



**KNOB POSITION:
HIGH FLAME**



**KNOB POSITION:
LOW FLAME**

Rotisserie Setup

Diamond Grill Rotisserie Setup

1. Insert Rotisserie Motor into Motor Bracket Assembly.
2. Slide Prong Forks with the prongs facing away from the handle into Spit Rod. So that any food item will be in the center between the two four prong forks.
3. Assemble Key Washer, Counter-balance and handle to Spit Rod. Slide Shaft Collar with long end towards handle.
4. Insert motor extension cord three prong plug into an adjacent grounded GFCI receptacle outlet.
5. Before placing food item on forks when the rotisserie is being operated exclusively, it is strongly recommended that a pan be placed on the grilling grids, beneath the food to catch the meat drippings. This will prevent excessive build up of drippings on the grids and facilitate cleaning. When food item is placed on rotisserie, be sure that all Bolts are tightened securely.
6. The rotisseries rod comes with a counter balance weight, adjust it as needed. Start the motor and make sure the meat is balanced on the spit so that it turns evenly. You may need to adjust the grate and drip pan if your meat is large. Make sure the meat can turn with no obstructions.
7. Close the lid while the rotisserie does its job. The rotation evenly melts the fat in the meat and naturally bastes the meat, but you may wish to baste with a mop sauce occasionally during grilling. When done, remove the spit using insulated oven mitts. Place the meat on a clean platter and cover it with foil while it rests.

Electrical Grounding Instructions:

The rotisserie motor is equipped with a three-prong grounding plug for your protection against electric shock. This plug must be inserted directly into a properly grounded three-prong receptacle. Do not cut or remove the grounding prong from this plug.

The rotisserie motor must be electrically grounded in accordance with local codes or, in the absence of local codes, in accordance with the National Electrical Code, ANSI/NFPA 70-1990 or Canadian Electrical Code, CSA C22.1.

Do not use an extension cord to supply power to your grill. Such use may result in fire, electrical shock or other personal injury. Do not install a fuse in the neutral or ground circuit. A fuse in the neutral or ground circuit may result in an electrical shock hazard. Do not ground this appliance to a gas supply pipe or hot water pipe.

⚠ WARNING: Never stand with your head directly over the Grill when preparing to light the Rotisserie Burner, to prevent possible bodily injury. Never operate Rotisserie Burner with main (other) burner(s) "ON". Warming Rack must be removed or in Tilt-Away Position when Rotisserie Burner is ON.

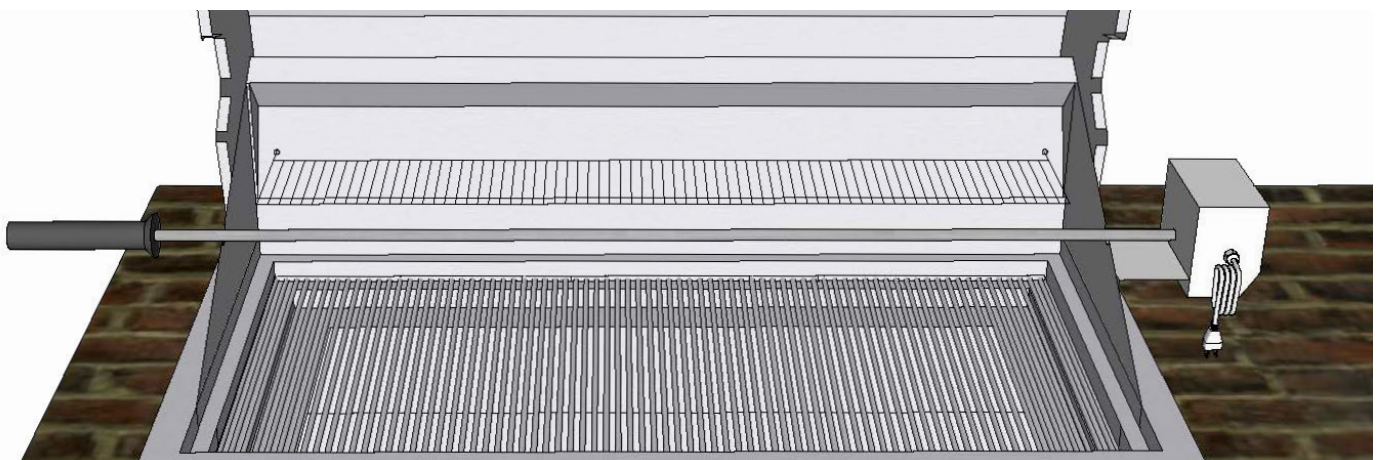

Rotisserie Setup

Installing your Rotisserie:

If you ordered our **DIAMOND ROTISSERIE** - follow these steps to learn how to set up your **DIAMOND ROTISSERIE**.



Place the **DIAMOND ROTISSERIE** motor on the left or right side of your **DIAMOND SERIES**, rotisserie holder. The **DIAMOND ROTISSERIE** slides down on the rotisserie holder and locks into place.



Place the rotisserie rod on the other end of the rotisserie holder. Make sure the screw is between the holder and the hood wall.

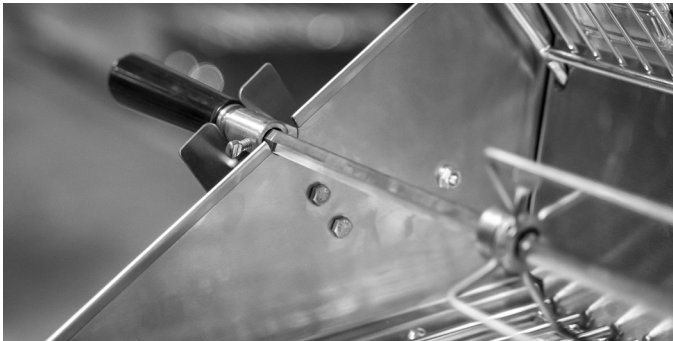

This is how your Rotisserie rod should look once it is assembled.



This is how your **DIAMOND ROTISSERIE** should look on the other side. The counter weight should be on the inside not outside.

How to use the Counter Weight?

The **DIAMOND ROTISSERIE** has a counter weight that helps keep strain on the motor balanced. This will help avoid damaging the gears and maintain an even cooking rate, resulting in a smooth spin.



Grill Features



Diamond Series Blow Torch:

Your **DIAMOND SERIES** comes equipped with our innovative **BLOW TORCH**, which makes turning on your grill instant and Reliable. The **DIAMOND SERIES BLOW TORCH** uses the proper air and fuel mixture to create a contained discharge that will Instantly turn on your **HIGH-PERFORMANCE BURNERS**.

Adjust Your Burners:

The bolt on the Right side of each burner is called the “AIR ADJUSTMENT” and it regulates the amount of air that enters into the burner for combustion. The air venturi adjustment screw is accessible by using your hand, be sure burner is not hot.

- If the flame is yellow, indicating insufficient air, turn the air adjustment bolt counterclockwise to allow more air to the burner.

- If the flame is noisy and tends to lift away from the burner, indicating too much air, turn the air adjustment bolt clockwise.

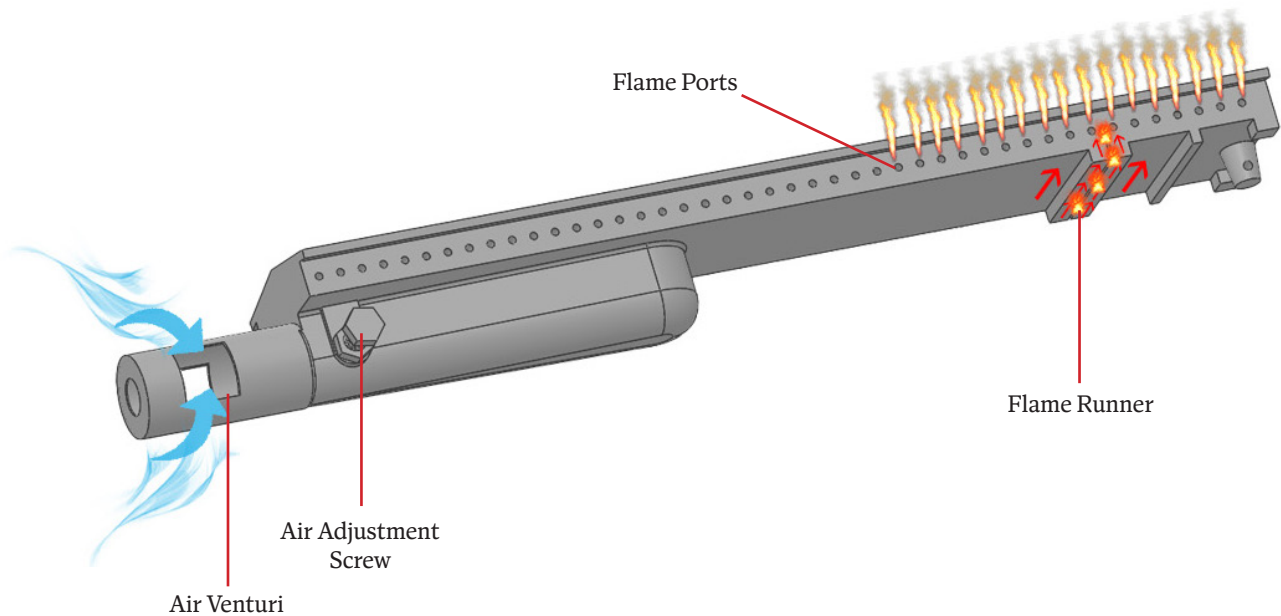
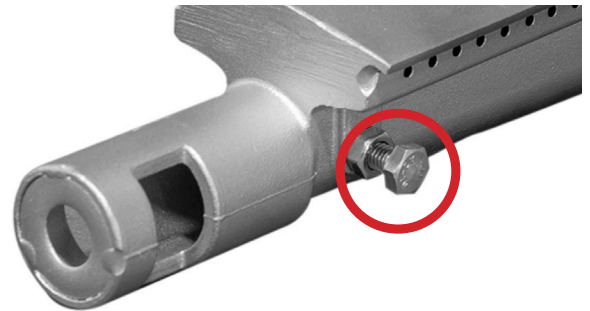

Grill Features

Correct Flame Color:

Flames should be blue and stable with no yellow tips, excessive noise or lifting. If any of these conditions exist, check if the air adjustment or burner ports are blocked by dirt, debris, or spider webs. If needed, proceed with air adjustment screw. The amount of air which enters a burner is governed by an adjustable bolt at the inlet. It is locked in place by a set screw which must be loosened prior to lighting the burner for adjustment. **FLAMES SHOULD BE BLUE AND STABLE WITH NO YELLOW TIPS, EXCESSIVE NOISE OR LIFTING.**

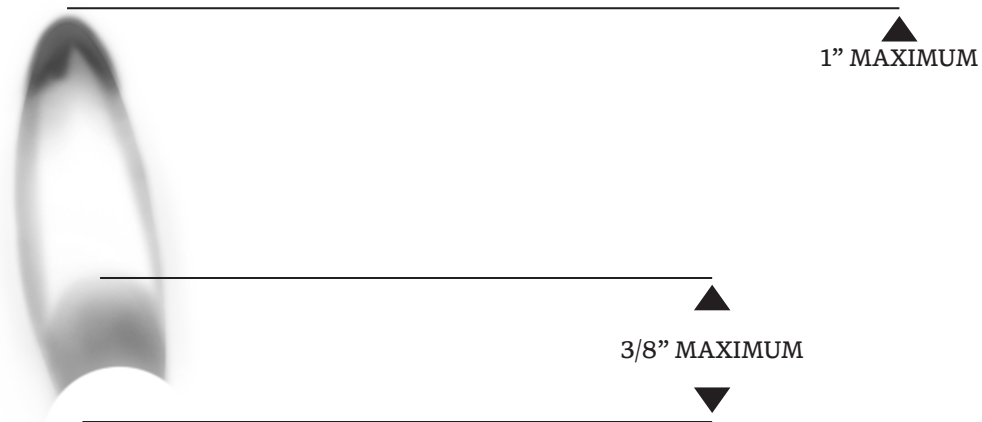

Combustion Chamber Balance

If the flame is noisy and tends to lift away from the burner, it indicates that there is too much air, turn the air adjustment screw clockwise to adjust.

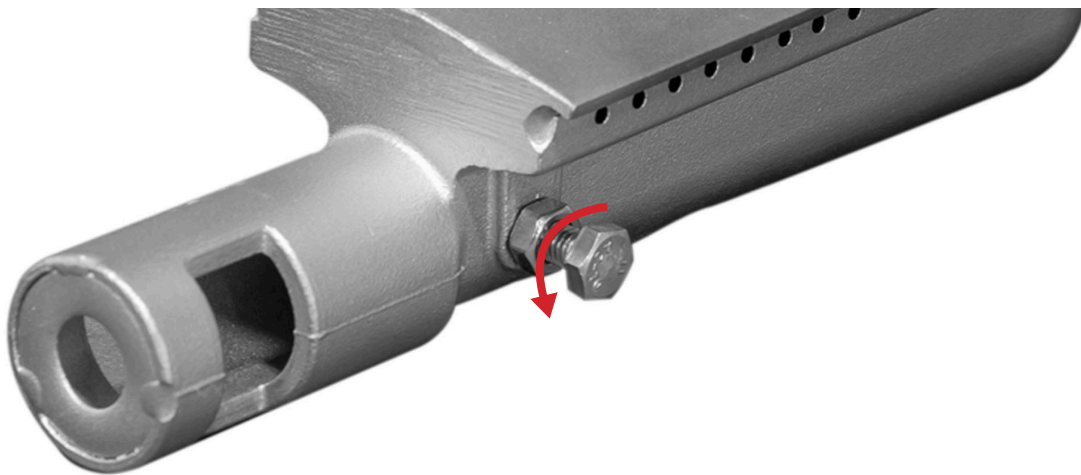

CARE & MAINTENANCE

CLEANING OF GRILL HOUSING:

Burn-off the grill after use will keep it ready for instant use, however, once a year you should give the entire grill a thorough cleaning to keep it in top operating condition.

1. Shut off gas supply at source and disconnects fuel line. Protect fuel line fitting.
2. Remove and clean the cooking grids, flavor bars and burners.
3. Remove warming rack and wash with mild detergent and warm water.
4. Cover the gas valve orifices with a piece of aluminum foil. 5. Brush the inside and bottom of the grill with a stiff wire brush, and wash down with a mild soap and warm water solution. Wash thoroughly and let it dry.
6. Remove aluminum foil from orifices and check orifices for obstruction.
7. Check electrode for damage and ware.
8. Reinstall flavor bars, cooking grids, and warming rack.

IMPORTANT: You should NOT line the bottom of the grill housing with aluminum foil, sand or any other grease absorbent Substance. Grease will not be able to drip into the drip tray and a grease fire may occur.

MAINTENANCE GUIDELINES

1. Keep outdoor cooking gas appliance area clear and free from combustible materials, gasoline and other flammable vapors and liquids.
2. Do not obstruct the flow of combustion and ventilation air.
3. Keep the ventilation opening(s) of the cylinder enclosure free and clear from debris.
4. Visually check burner flames. Burner flames should be blue and stable with no yellow tips, excessive noise, or lifting.
5. Clean outdoor cooking gas appliance, including special surfaces, with recommended cleaning agents, if necessary.
6. Check and clean burner for insects and insect nests. A clogged tube can lead to a fire beneath the grill.

RUST-BROWN MARKS:

When this type of staining occurs, it is unlikely that rusting of the stainless steel itself causes the marks. Similar marks can be found with both porcelain and plastic sinks. The rust marks are the result of small particles of “ordinary-steel” which have become attached to the surface; these have subsequently rusted in the damp environment. The most common source of such particles is from “wire wool” scouring pads, but contamination may also occur from carbon steel utensils and old cast iron water supply pipes. These brown marks are only superficial stains, which will not harm the Grill; they should be removable using a soft damp cloth and a multi-purpose cream cleanser. Occasionally, it may be necessary to resort to a proprietary stainless-steel cleanser, to return the surface of the Grill to its original condition. To avoid re- occurrence of any “rust-staining” it is essential that the source of the contamination be eliminated.

PITTING:

Another form of corrosion, which occasionally occurs in stainless steel, is pitting of the surface. The reason for this corrosive attack can usually be attributed to certain household products. Such as.

BLEACHES:

Most common domestic bleaches & sterilizing solutions contain chlorine in the form of sodium hypochlorite. If used in concentrated form, bleaches can attack the stainless steel, causing pitting of the surface. They should always be used to the strengths prescribed by the manufacturer and should be thoroughly rinsed off with clean water immediately after use. All cleaning agents containing hypochlorite are unsuitable for long term contact with stainless steel and, even when used in the highly diluted form, they can give pitting under certain conditions.

FOODSTUFFS:

In general, stainless steel is fully resistant to all foodstuffs in common use. Only in isolated cases, such as when concentrated salt and vinegar mixtures can remain in contact with the steel for a long period can any surface marking result.

CARE & MAINTENANCE

MAKE SURE GRILL IS COMPLETELY COOL BEFORE CLEANING:

You should clean your appliance after each use to maintain the overall appearance over the life of your appliance. After the first use, it is normal for your appliance to become discolored in certain areas from the heat produced by the burners.

EXTERIOR CLEANING:

When cleaning your appliance, always scrub and polish in the direction of the stainless steel grain. Wipe down the exterior of the appliance to remove any splatter or grease. Do not use harsh abrasives. Use a stainless steel cleaner to clean the exterior surface for a polished look. To remove baked-on foods, use a fine to medium grit nonmetallic abrasive pad with a stainless steel cleaner to avoid specks of grease collecting in the grain causing the appearance of rust. Before installing the cover, always allow the surface to dry. DO NOT cover a damp appliance.

DRIP TRAY:

Clean the drip tray after each use. Failure to do so could result in a fire. Once the appliance has cooled completely, remove the tray by pulling it all the way out until it comes free. Clean the tray with hot soapy water and replace ensuring the tray is installed completely in the grill housing.

FLAME TAMERS, GRATES & WARMING RACKS:

To clean (should clean after each use), turn the main burners on HIGH for 10-15 minutes with the hood closed. This allows any food particles or grease drippings to burn away. Brush components with a stainless steel bristle brush to remove any remaining charred materials.

CAST STAINLESS STEEL BURNERS:

The appliance must be completely cooled before proceeding. Make sure the gas supply is off and all control knobs are in the “OFF” position. You must remove all cooking grids and flame tamers to expose the main burners in the appliance. On the bottom rear of each burner is a cotter pin accessible from the back of the grill head. Remove cotter pins (unless they were removed prior to installation into an outdoor kitchen). To remove burner, pull rod upwards and slide burner toward the rear of the appliance. Repeat for each burner. To clean the burners, use a wire brush to clean the exterior of the burner. Free all clogged ports of obstructions with a small metal object. Clean out any debris through the air shutter and inspect the burner inlet to ensure it is free of any obstructions. Use a rod or pipe cleaner to remove any debris within the burner if necessary.

SPIDERS & INSECT WARNINGS:

Spiders and other insects can nest in the burner of this and any other burner, which causes the gas to flow from the front of the burner. This dangerous “condition” can cause a fire behind the valve panel, damaging the burner and making the burner unsafe to operate. Inspect the burners before each use. Symptoms of insect nests can include any of the following conditions:

- 1) The smell of gas in conjunction with the burner flames appearing yellow.
- 2) The burner does not reach temperature.
- 3) The burner heats unevenly.
- 4) The burner makes popping noises.



WARNING: Make sure each burner is properly placed after cleaning. It is very important to ensure the end of the burner is installed appropriately onto the gas valve to ensure gas flows safely into the burner. Failure to meet these conditions can cause dangerous conditions that can cause personal injury and/or property damage.



DIAMOND GRILLS BBQ

GRILL - WARRANTY INFORMATION

DIAMOND GRILLS BBQ offers a warranty on our grills, griddles, and side burners to the original purchaser with proof of purchase. Our products are guaranteed to be free from defects in both workmanship and materials for the specified periods below. This warranty is not applicable to grills used in commercial or rental applications. Any issues related to rust, corrosion, oxidation, or discoloration due to moisture or overheating are not covered under this warranty, unless such issues render the affected component inoperable. Additionally, this warranty does not include labor or labor-related charges. If warranty parts need to be shipped, customers will be responsible for any associated shipping and handling fees. Thank you for choosing Diamond Grills BBQ.

LIMITED LIFETIME WARRANTY:

DIAMOND GRILLS BBQ offers a LIFETIME WARRANTY for the cast stainless steel burners included with our grills. This warranty covers any defects in material and workmanship that may arise during normal residential use, except for discoloration, surface scratches, weather-related staining, and minor rust and oxidation, which are typical for outdoor products. In the event of any such defect, the burner will be repaired or replaced at no charge, while the owner will be responsible for all other expenses, including labor and freight. Please be advised that this warranty only applies to grills featuring our cast stainless steel burners, and that it does not cover commercial or rental use. Customers are also responsible for any shipping and handling fees associated with warranty parts.

TWO-YEAR WARRANTY:

DIAMOND GRILLS BBQ provides a TWO-YEAR WARRANTY for the following parts of our grills: Fire Box, Hood, Handle, Bezel, Grates, Flavor Bars, Drip Pan, Rotisserie Burner, Transformer, Warming Rack, and Flame Tamer. This warranty guarantees these parts to be free from defects in materials and workmanship during normal residential use for two years from the original purchase date. If any of these parts are found to be faulty, we will repair or replace them at no cost to the customer, except for expenses related to labor and freight.

ONE-YEAR WARRANTY:

DIAMOND GRILLS BBQ provides a ONE-YEAR WARRANTY on the grill components, including the gas valve, knob, and light, against any defects in materials and workmanship during normal residential use from the original purchase date. This warranty does not cover damages or malfunctions resulting from neglect, misuse, alterations, accidents, or improper installation, maintenance, or repairs.

LIMITATIONS & EXCLUSIONS:

The warranty provided by DIAMOND GRILLS BBQ is applicable only to products purchased and located within the United States and Canada. The coverage period begins on the original purchase date, and proof of purchase is mandatory.

To activate the warranty, customers must register the product online at:

www.diamondgrillsbbq.com/product-registration-and-warranty

Please note that this warranty does not cover damages resulting from negligence, alteration, misuse, abuse, accidents, natural disasters, loss of electrical power, improper installation or operation, unauthorized adjustments or calibrations, dings, dents, scratches, or damages caused by harsh cleaning chemicals. The warranty is not valid for commercial use or for products with altered or removed serial numbers. DIAMOND GRILLS BBQ will not be liable for any incidental, consequential, special, or contingent damages arising from the breach of this written warranty or any implied warranty.

WARRANTY CLAIM PROCEDURE:

Please contact DIAMOND GRILLS BBQ Warranty Service Center for factory direct assistance. We are open Monday-Friday 7am-5pm (PST)

Phone Number: (909) 460-5579

Email: support@diamondgrillsbbq.com

Grill - Warranty Information

LIFETIME WARRANTY	2-YEAR WARRANTY	1-YEAR WARRANTY
Cast Stainless Steel Burner	Bezel Grates Flavor Bars Handle Drip Pan Hood Rotisserie Burner Transformer Warming Rack Flame Tamer Fire Box	Gas Valve Knob Light



SCAN TO REGISTER YOUR PRODUCT ONLINE

Welcome & Congratulations

Congratulations on your purchase of a new Diamond Grill Series! We are very proud of our product and we are completely committed to providing you with the best service possible. Your satisfaction is our #1 priority. Please read this manual carefully to understand all the instructions about how to install, operate and maintain for optimum performance and longevity. We know you'll enjoy your new grill and thank you for choosing our product. We hope you consider us for future purchases.

How to Obtain Service

Please make sure you have the following information:

- MODEL NUMBER
- DATE OF PURCHASE
- INVOICE NUMBER. KEEP A COPY OF THE GRILLS ITEMIZED INVOICE FOR YOUR RECORDS

For warranty service, contact DIAMOND GRILLS BBQ Customer Service Department at (909) 460-5579 or email sales@diamondgrillsbbq.com

DIAMOND GRILL BBQ
701 S Dupont Ave, Ontario, CA 91761

Business Hours:
Mon-Fri: 7:00AM - 5:00PM
Closed: Sat - Sun

Contact Information:
Phone: (909) 460-5579
Email: support@diamondgrillsbbq.com

SCAN QR CODE
TO ACTIVATE YOUR WARRANTY



Make a copy of your sales slip for proof of purchase

Name: _____

Address: _____

Model No: _____ Serial No: _____

Date Of Purchased: _____

DO NOT TEAR - THIS IS YOUR COPY