

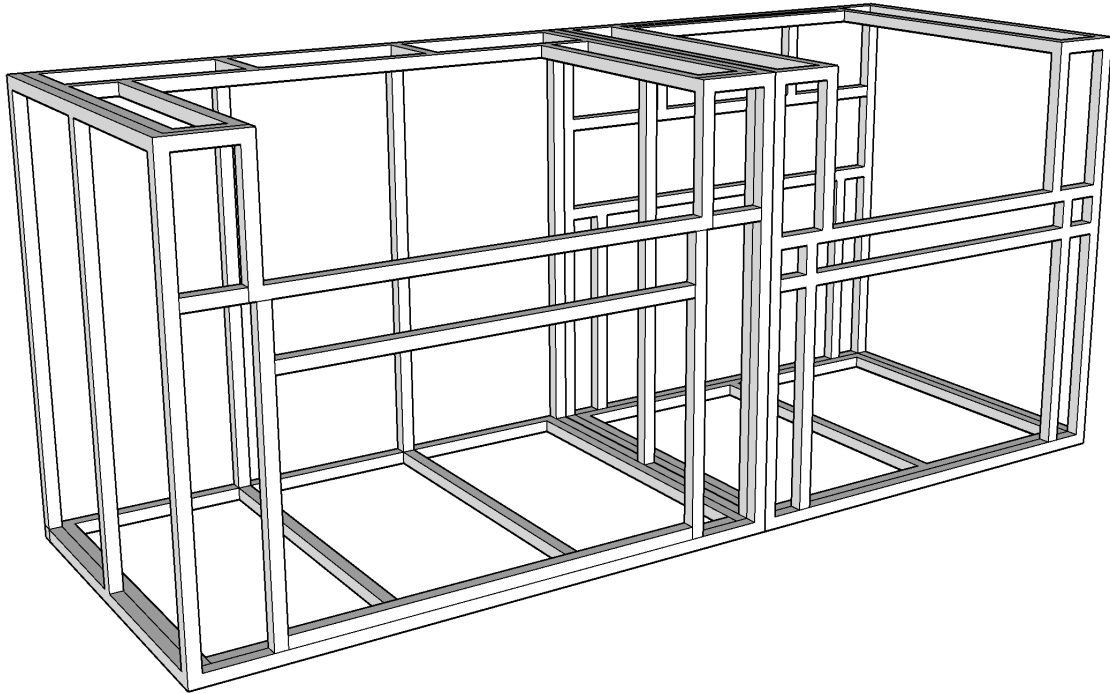

2-ISLAND BBQ

ASSEMBLY INSTRUCTIONS



Includes:

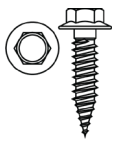

28x*

H Bar

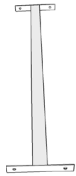

1x

Front Panel

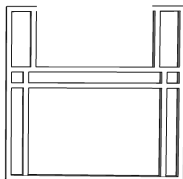

2x

Back Panel

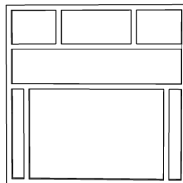

2x

Side Panel



2x

Top Panel

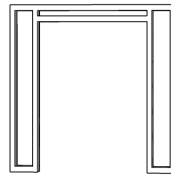

2x

Tools Needed:

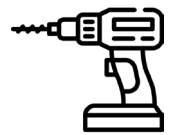

Drill or Impact Driver



**WATCH
ON
YouTube**

*Amount of self tapping screws may vary.

*Islands may vary. General Instructions remain the same.

1.

2.

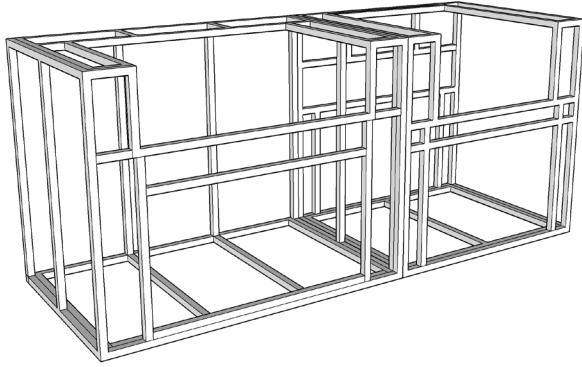

KD BBQ ISLAND

- 1. 36" Diamond Series DG-4B36 [LP/NG]
- 2. 24" Double Side Burner DG-DSB [LP/NG]

- 1. 48" Island
- 2. 24" Island

*Islands may vary. General Instructions remain the same.

- 1. Start by securing one corner of the BBQ Island. Connect "FRONT 1" with "SIDE 1" at a right angle.

Make sure to place the brackets on the inside, facing upwards.

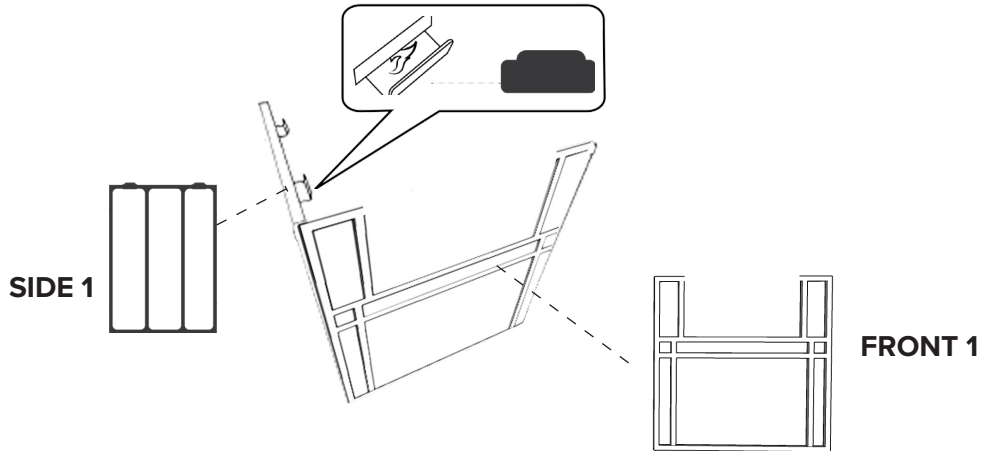

- 2. Attach "BACK 1" to "SIDE 1" at a right angle.

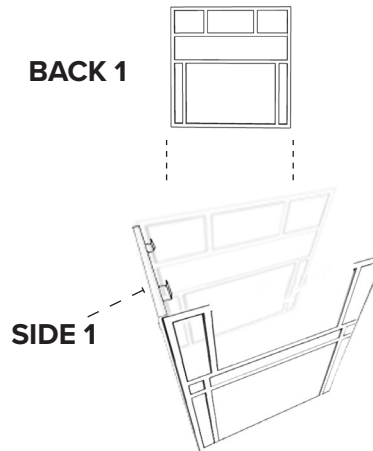

- 3. Connect "BACK 2" to "BACK 1" side-by-side.

Then connect "FRONT 2" to "FRONT 1" side-by-side.

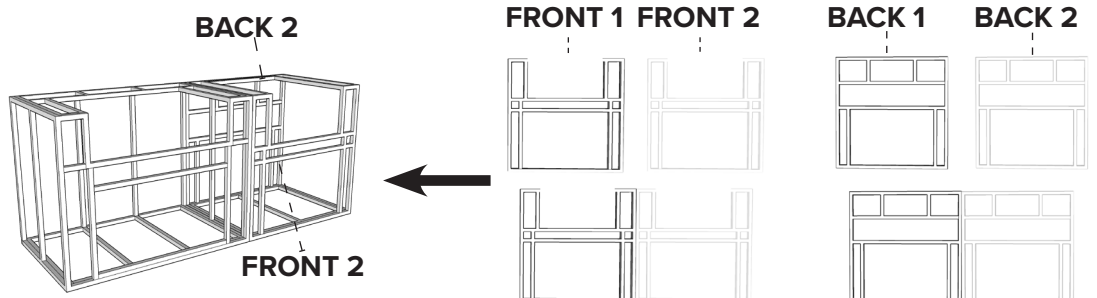

- 4.** Connect one end of "SIDE 2" to "BACK 2" forming a right angle.

Then, connect the other end of "SIDE 2" to "FRONT 2" also at a right angle.

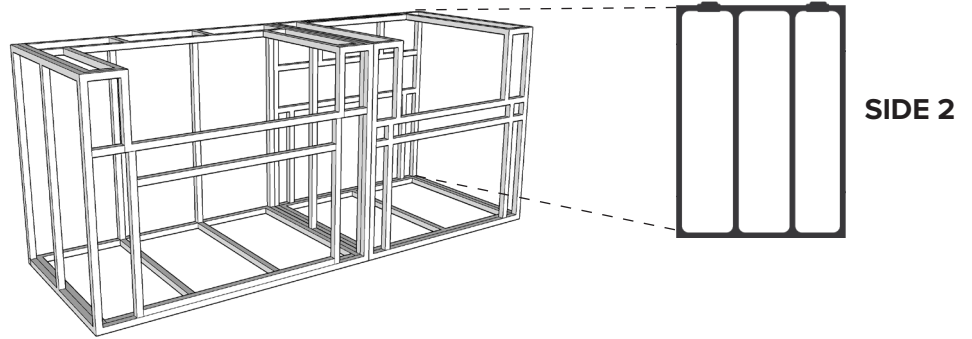

- 5.** Place "TOP 1" on top of "Island 1" with the opening of the panel facing the front of the island.

Place "TOP 2" on top of "Island 2" with the opening of the panel facing the front of the island.

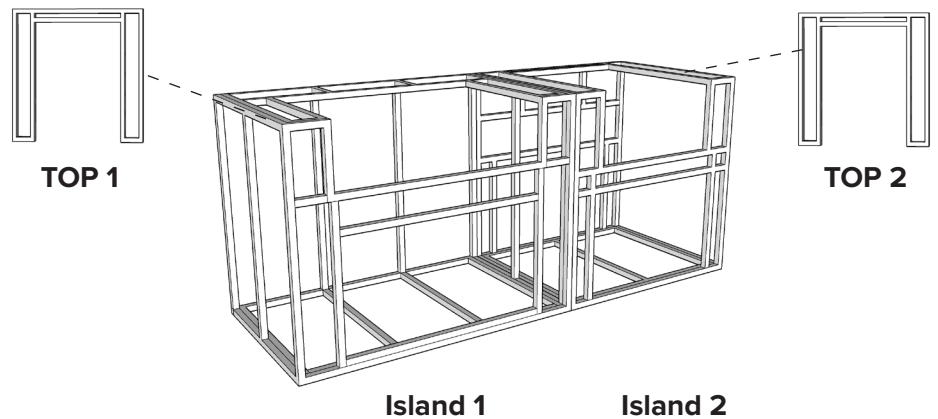

- 6.** Place "H Bar" horizontally between both islands.

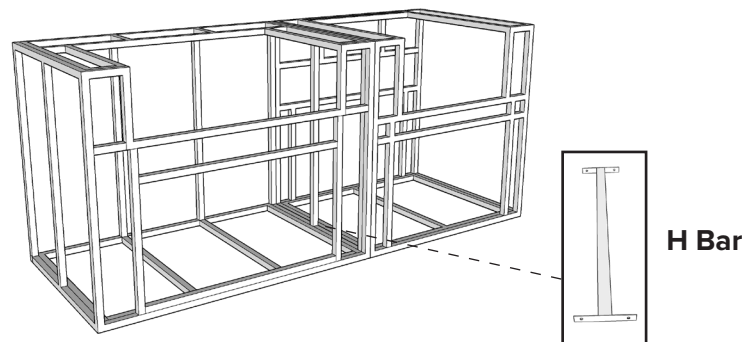

- 7.** Ensure **ALL** panels are placed correctly and screwed together.

